



Gas detection system
for DIN rail mounting

smart
GasDetection
Technologies



Operation manual

D-ReX Pol

Translation of the operation manual
245-002.30b_OM_D-ReX_Pol
Version 1 of December 12, 2023

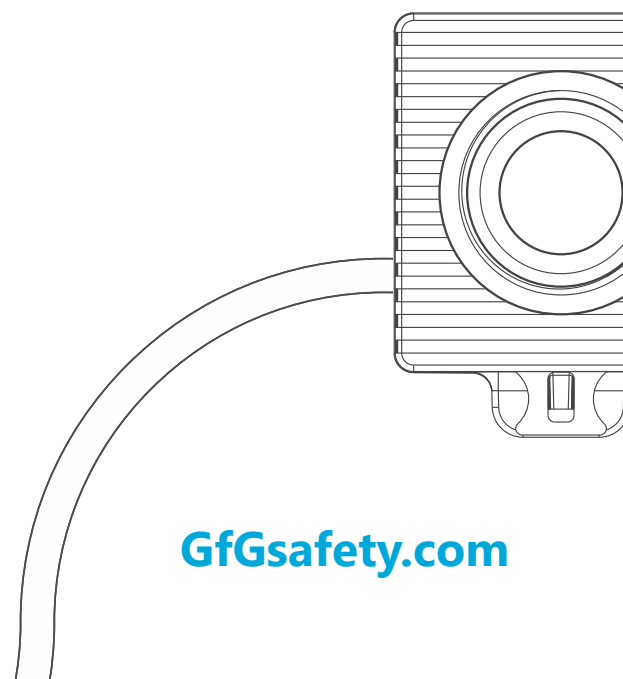
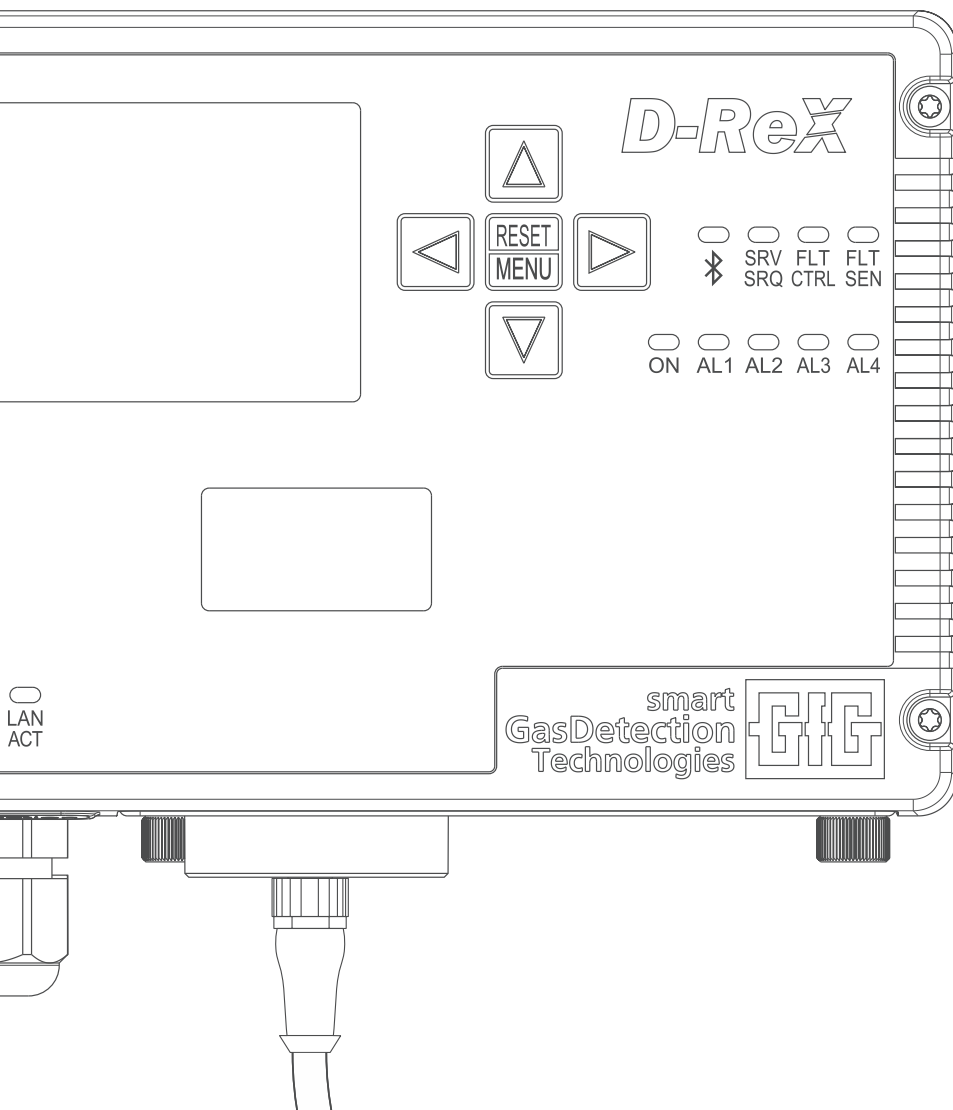

[GfGsafety.com](https://www.GfGsafety.com)

GfG Gesellschaft für Gerätebau mbH

Klönnestraße 99
44143 Dortmund
Deutschland

Phone: +49 231 564 00-0
Fax: +49 231 564 00-895
Email: info@gfg-mbh.com
Web: GfGsafety.com

The original operation manual was created in German.

© Copyright 2023 – Copyright notice.

All contents of these operation manual, in particular texts, photographs and graphics, are protected by copyright. Unless otherwise expressly indicated, the copyright is held by GfG Gesellschaft für Gerätebau mbH. Please contact us if you wish to use the contents of this manual.

Anyone who infringes copyright (for example, copies images or texts without permission) is liable to prosecution under §§ 106 et seq. of the German Copyright Act (UrhG), will also be issued with a warning and must pay damages (§ 97 UrhG).

Information on the operation manual

This operation manual enables you to safely and efficiently use the D-ReX®* Pol 1-gas detection system. It is part of the product and must be kept close to the gas detection system, available to any user, at any time.



CAUTION

Read this operation manual carefully before beginning any work. Observe all stated safety and operation instructions. Observe all national and international safety and accident prevention regulations.

GfG customer service

Germany

Phone: +49 231 56400-0

Email: info@gfg-mbh.com

Änderungsverzeichnis

Revision	Date of issue	Change	Editing	Approval
1	Dec. 12, .2023	First edition	Mironiuk	Böttger

Table of contents

1. Overview	7
1.1 Design D-ReX Pol	8
1.1.1 Housing	8
1.1.2 Housing cover (front)	9
1.1.3 Housing interior	9
1.1.4 Adapter cartridge	10
1.1.5 Sensor cartridge	10
1.1.6 Connection cable	11
1.1.7 Mounting bracket	11
1.1.8 Saddles	11
1.2 Optional components	12
1.3 Further applicable documents	13
2. Safety	14
2.1 Manufacturer	14
2.2 Disclaimer	14
2.3 Subject to alterations	15
2.4 Place of storage	15
2.5 Symbols in this manual	15
2.6 Safety information in handling instructions	16
2.7 Warning signs used in this document	17
2.8 Other markings	17
2.8.1 General notation	17
2.8.2 Definition of terms	18
2.8.3 Abbreviations and SI units	19
2.9 Intended use	20
2.10 Due diligence of the operator	20
3. Functional design	21
3.1 Control buttons and display	21
3.1.1 Control buttons	22
3.1.2 Status-LEDs	22
3.1.4 Window to sensor cartridge	23
3.1.5 TFT color display	24
3.2 Visual and acoustic alarms	25
3.3 Digital RS-485 interface	25
3.4 Relays	26
3.4.1 Internal Relays (optional)	26
3.4.2 External relay module (optional)	26
3.4.3 Configuration of the relays	26
3.5 Analog outlet	28
3.6 Sensors	29
3.6.1 Smart electrochemical sensors (EC)	30
3.6.2 Smart Infrared sensors (IR)	31
3.6.3 Smart catalytic sensors (CC)	31
3.6.4 Advanced sensor data	31
3.7 Accessories (optional) and spare parts	32

Table of contents

4. Mounting and Installation	33
4.1 Mounting location.....	33
4.2 Mounting the housing.....	34
4.3 Attaching the sensor cartridge using a mounting bracket.....	35
4.4 Attaching the sensor cartridge on the mounting saddle.....	35
4.5 Electrical connections.....	36
4.5.1 Current supply.....	36
4.5.2 Terminal assignment plan – connecting the device.....	36
4.5.3 Terminal assignment plan – relays.....	38
4.6 Commissioning.....	39
5. Operation instructions	40
5.1 Keypad and operation.....	40
5.2 Measuring mode.....	41
5.3 Main menu.....	42
5.3.1 State D-ReX.....	43
5.3.2 Info.....	44
5.3.2.1 Info: D-ReX.....	44
5.3.2.1.1 Info: Software.....	45
5.3.2.1.2 Info: System.....	45
5.3.2.1.3 Info: Network.....	46
5.3.2.1.3.a IPv4.....	46
5.3.2.1.3.b Modbus/TCP.....	47
5.3.2.1.3.c Webserver.....	47
5.3.2.1.3.d Configuration.....	47
5.3.2.1.4 Info: Busses.....	48
5.3.2.1.4.a Modbus 1.....	48
5.3.2.1.4.b Modbus 2.....	49
5.3.2.1.4.c Modbus 3.....	49
5.3.2.1.4.d Modbus LON.....	50
5.3.2.2 Info: Measurements.....	50
5.3.2.2.1 1: Gas Sensor.....	51
5.3.2.3 Info: Internal relays.....	52
5.3.2.3.1 Relays (1-5) Alarm X.....	53
5.3.2.4 Help.....	53
5.3.2.4.1 Abbreviation.....	54
5.3.2.4.2 Information.....	54
5.3.2.4.3 Licenses.....	54
5.3.3 Tests.....	55
5.3.3.1 Test: LEDs.....	55
5.3.3.3 Display Test.....	56
5.4 Service Menu.....	58
5.4.1 Measurements.....	59
5.4.1.1 Gas Sensor.....	59
5.4.1.1.1 ZERO-Adjustment.....	60
5.4.1.1.2 SPAN-Adjustment.....	62
5.4.1.1.3 Alarms.....	64
5.4.1.1.4 Measuring range.....	66
5.4.1.1.5 Sensor Information.....	67
5.4.2 Relay tests (intern).....	67

Table of contents

6. Service	69
6.1 Cleaning and Care	69
6.2 Service and maintenance.....	69
6.2.1 Visual check.....	70
6.2.2 Functional check.....	70
6.2.3 System check (Proof Test).....	71
6.2.4 Sensor replacement for external sensor cartridges	72
6.2.5 Calibration and adjustment.....	73
6.2.5.1 Zero gas and test gas.....	73
6.3 Note on the environmentally safe disposal of used parts.....	74
6.4 Technical specifications.....	75
6.5 Declaration of Conformity.....	77
6.6 Package dimensions and Mounting template.....	78

1. Overview

The D-ReX PoI (Point of Installation), called only "D-ReX" in the following text for simplicity's sake, is an independent 1-gas detection system for DIN rail mounting. It is used for monitoring gas concentrations via an external sensor (remote sensor).

The sensor cartridge can be located up to 30 meters away and either positioned freely or mounted on piping or flat surfaces using a saddle.

It can monitor the oxygen concentration as well as toxic or combustible gases and vapors outside of Ex zones in diffusion mode.

The D-ReX comes with a high-resolution color display, 11 status LEDs and 5 control buttons and offers a variety of communication options, including Bluetooth®* and PoE communication.

Optional add-ons:

- » 5 internal relays
- » LonWorks®* communications module
- » IP64** version

D-ReX-models and pyrolyzer

Aside from the PoI, the D-ReX series also includes a pyrolyzer and the following model versions:

» D-ReX PoU (Point of Use)

A version with an internal sensor cartridge for monitoring the gas concentration at the point of installation in diffusion mode.

» D-ReX PoS (Point of Sampling)

A version with integrated pump for absorbing the monitored gas sample. The sensor and pump module are both located within the device. The absorption distance can be up to 30 meters.

» Py-ReX®*

External pyrolyzer for pyrolytic disintegration of gases that can either not be monitored directly or are too dangerous. The sensor will then monitor the flow of gas for disintegration byproducts of the target gas, whose equivalent is used to calculate the concentration of target gas. The Px-ReX can only be used in combination with the D-ReX PoS and is installed upstream from it. The maximum absorption distance is up to 30 meters.

* Bluetooth® and LonWorks® are registered trademarks of their respective owners.

D-ReX® and Py-ReX® are registered trademarks of GfG Gesellschaft für Gerätebau mbH.

** To qualify for protection class IP64, both the RJ-45 connector as well as an opening at the back of the D-ReX must be permanently sealed. The ethernet connection or "Power over Ethernet" (PoE) cannot be used in this case.

1.1 Design D-ReX Pol

1.1.1 Housing

- 1 Color display
- 2 Control buttons
- 3 Status LEDs
- 4 Alarm LEDs
- 5 Type label with serial number (on the side)
- 6 Window to adapter cartridge (type and connection)
- 7 Status LEDs LAN



D-ReX front view

- 8 RJ-45 connector
- 9 IP protection sticker (optional)
- 10 Cable glands M16 x 1.5
- 11 Bottom housing cover
- 12 Adapter cartridge inlet
- 13 Screen fixing screws

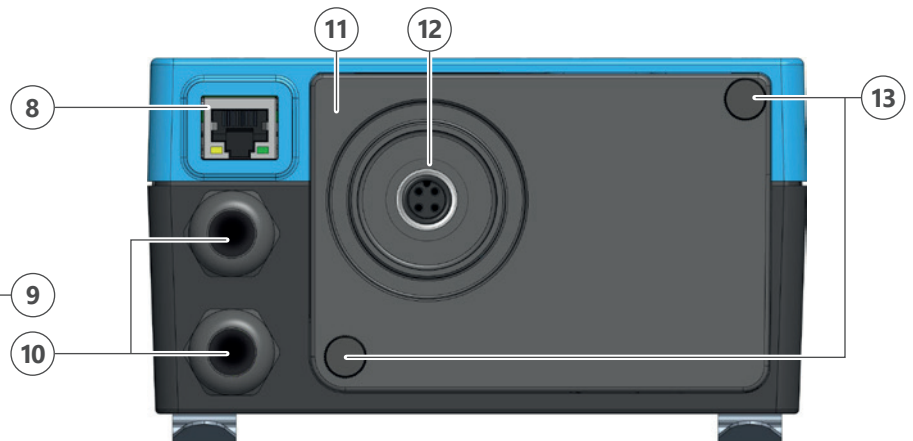

D-ReX bottom view

- 14 DIN rail clip
- 15 IP protection sticker (optional)

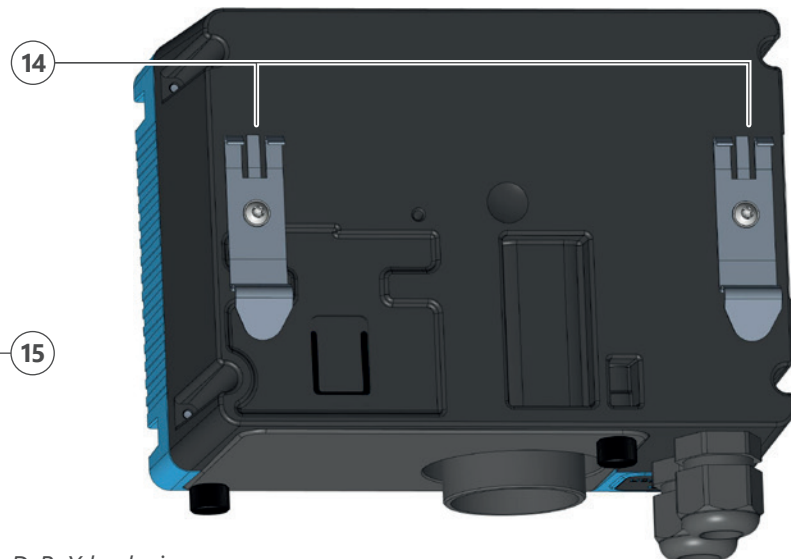

D-ReX back view

1.1.2 Housing cover (front)

- 1 Housing cover screws (Torx T10)
- 2 Main board with display
- 3 Terminal block PCB connector plug
- 4 Label: MAC adr. and serial number
- 5 Not used in Pol version
- 6 Window to adapter cartridge
- 7 RJ-45 connector

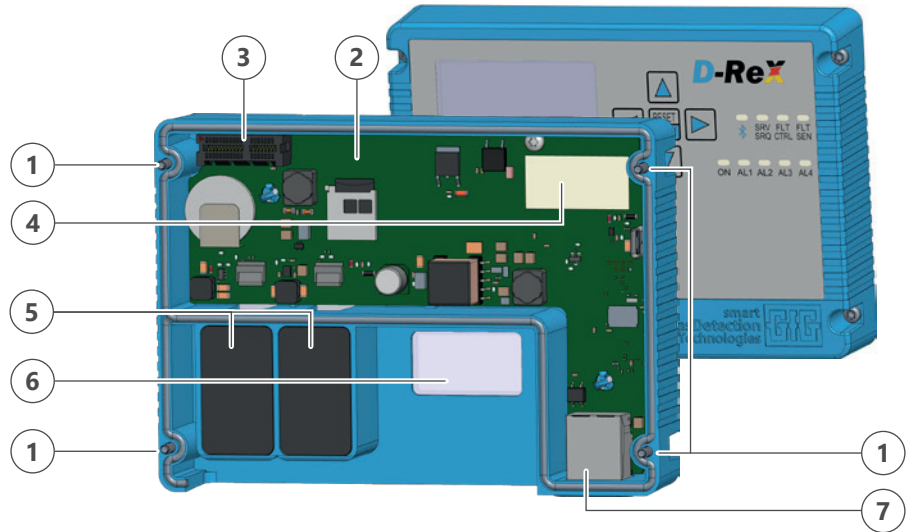

D-ReX housing cover - interior

1.1.3 Housing interior

- 1 Terminal block PCB
- 2 Relay PCB (optional)
- 3 LonWorks module (optional)
- 4 Cable glands M16 x 1.5
- 5 Adapter cartridge
- 6 Bottom housing cover
- 7 Fixing screw

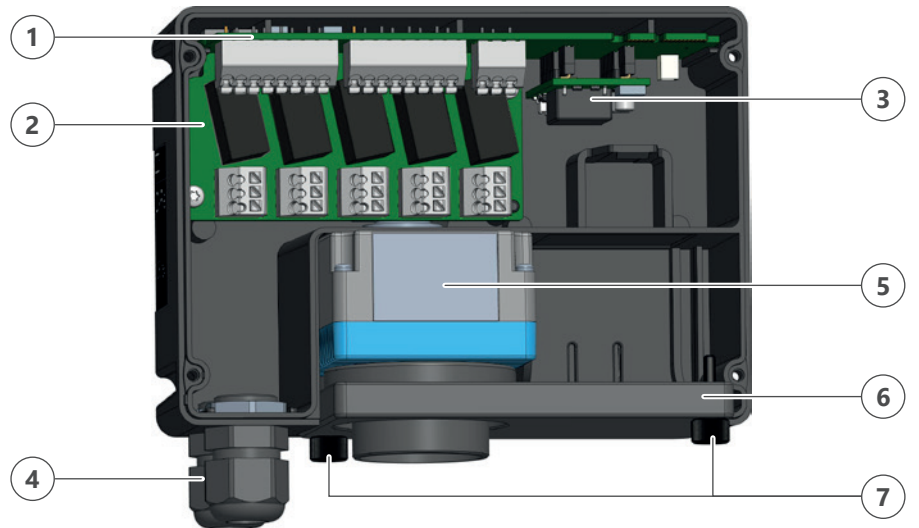

D-ReX housing interior with relay and LonWorks module

- 8 Connector PCB

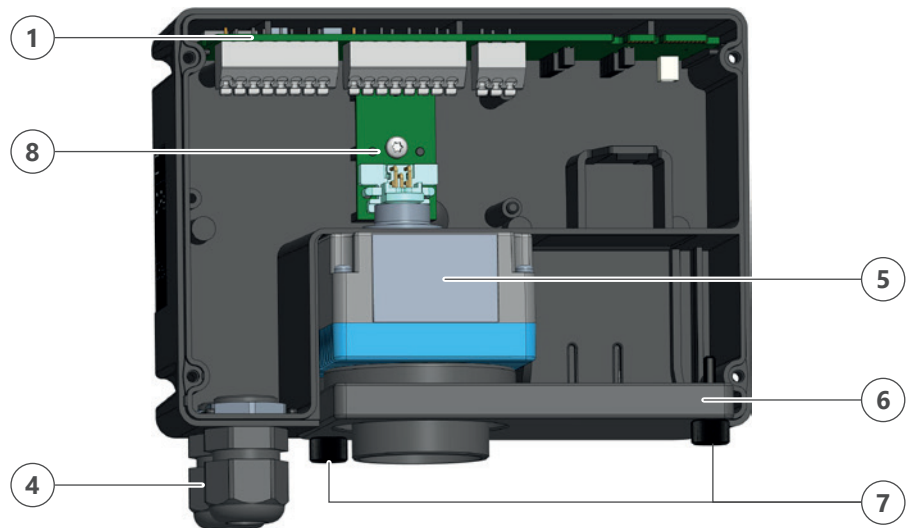

D-ReX housing interior with no optional components

1.1.4 Adapter cartridge

- 1 Adapter cartridge housing
- 2 Connector socket for housing PCB M12(M)
- 3 Connector socket for external sensor cartridge's cable M12 (F)

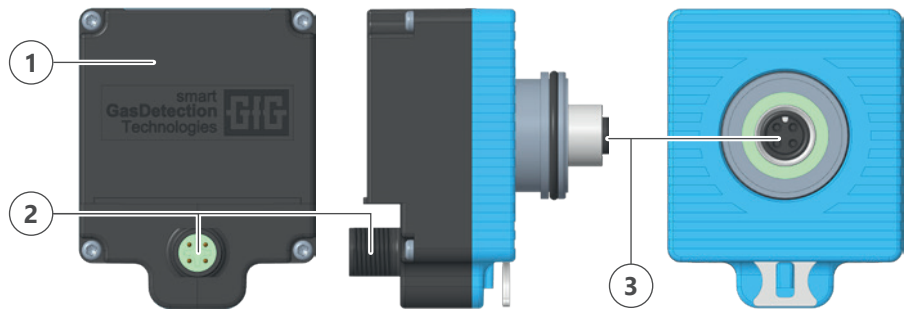

A label is attached to the sensor cartridge. It gives information on the sensor's type and connection.



Label Adapter cartridge

1.1.5 Sensor cartridge

- 1 Sensor cartridge housing
- 2 Connector socket for internal adapter cartridge's cable M12(M)
- 3 Bayonet lock with saddle / mounting bracket thread, including seal
- 4 Sensor

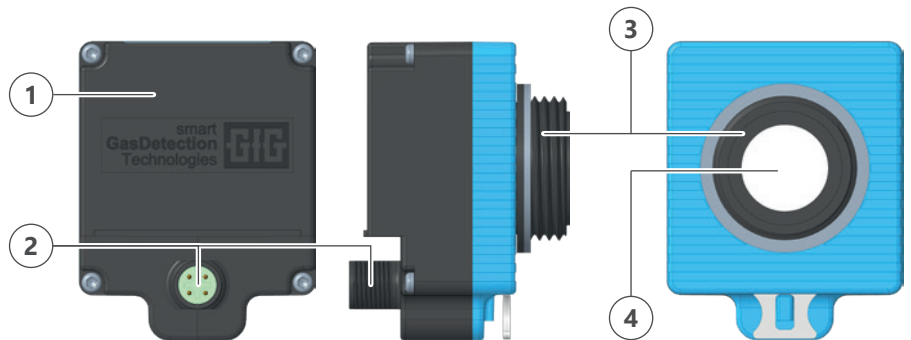

A label is attached to the sensor cartridge. It gives information on the sensor cartridge (on cartridges with no pre-installed sensors) or the installed sensor (on cartridges with a pre-installed sensor).

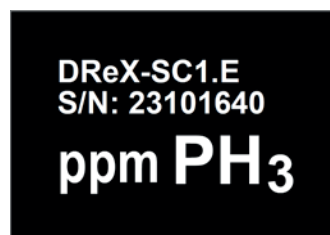

Sensor cartridge with sensor



Sensor cartridge without sensor

1.1.6 Connection cable

Connection cable with M12 plug, straight socket, 4-pin, with cable marker for connecting the sensor cartridge to the adapter cartridge. For available lengths, refer to section 1.2 Optional components (► page 11).

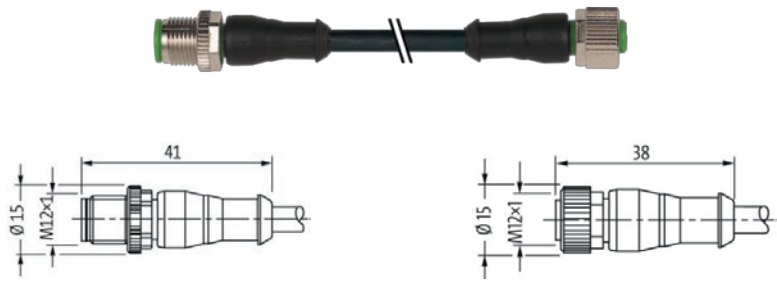

1.1.7 Mounting bracket

- 1 Mounting screw opening \varnothing 4.5 mm
- 2 Nut for attaching the sensor cartridge

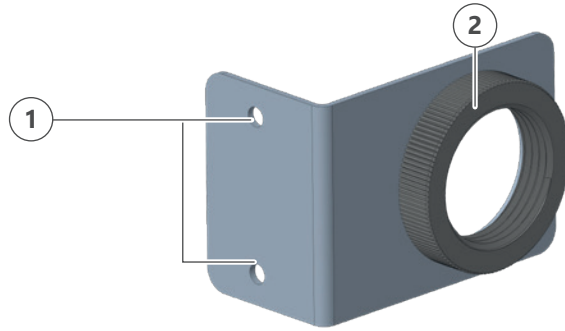

1.1.8 Saddles

- 1 Saddle for even surfaces
- 2 Saddle for curved surfaces (2", 3", 4", 6", 8", 10", 12")
- 3 Thread for bayonet lock
- 4 Silicone seal

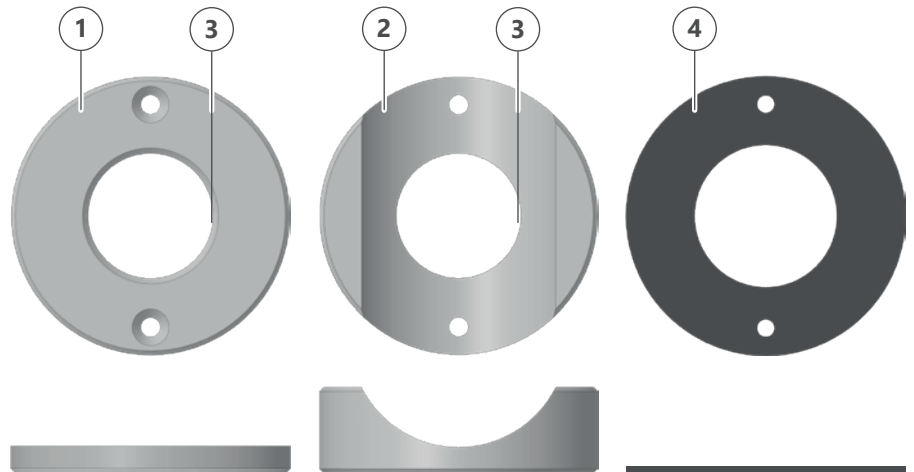

1.2 Optional components

The following add-ons are available for the D-ReX Pol:

Accessories	Item no.
Sensor cartridge (remote) for EC/IR/PID sensors, without sensor	3603001
Sensor cartridge (remote) for CC sensors, without sensor	3603002
Cable 1 m with M/F M12 connections	3604011
Cable 2 m with M/F M12 connections	3604012
Cable 3 m with M/F M12 connections	3604013
Cable 5 m with M/F M12 connections	3604014
Cable 10 m with M/F M12 connections	3604015
Cable 20 m with M/F M12 connections	3604016
Cable 30 m with M/F M12 connections	3604017
Mounting saddle for even surfaces for use with external sensor cartridges	3604021
Mounting saddle for 2" pipes and external sensor cartridges	3604022
Mounting saddle for 3" pipes and external sensor cartridges	3604023
Mounting saddle for 4" pipes and external sensor cartridges	3604024
Mounting saddle for 6" pipes and external sensor cartridges	3604025
Mounting saddle for 8" pipes and external sensor cartridges	3604026
Mounting saddle for 10" pipes and external sensor cartridges	3604027
Mounting saddle for 12" pipes and external sensor cartridges	3604028
Calibration adapter for reactive and highly reactive gases (remote cartridge)	3604041
Mounting bracket with nut for external sensor cartridges	3604020
DIN rail for D-ReX or Py-ReX 35/7,5 length 500 mm	3605101

Folgende Ersatzteile sind für das D-ReX Pol verfügbar:

Spare part	Item no.
Spare part: Bayonet lock for remote sensor	3603000
Adapter cartridge AC1 with M12 connection	3604001
Spare parts: Screen for D-ReX Pol	3604200

1.3 Further applicable documents

This technical document is complete in itself.



The following table lists all further applicable documents. If required, GfG will send you more information and additional copies of these documents.

» Configuration	Included upon delivery
» Testing protocol	Included upon delivery
» Declaration of conformity	(► page 77)
» Dimensioning	(► Seite 78)

Depending on the application configuration: Document number:

» Annex "Modbus Implementation"	245-002.22_ABA_DReX-Modbus
» Annex LonWorks implementation	245-002.23_ABA_DReX-Modbus
» Sensor data sheet	Depends on used sensor
» OM external relay module	222-002.24_OM_GMA200-RT

You must also adhere to all relevant laws, norms and guidelines for accident prevention and environmental protection of the country the product is used in.

If you think this operation manual contains any mistakes, discrepancies or ambiguities, contact the manufacturer before using this product.

2. Safety

This operation manual contains detailed descriptions for the safe and proper installation, connection, commissioning, use, maintenance and testing of the product. It also contains safety instructions and general information about the product.

It is intended exclusively for specially trained users and authorized technical personnel.



Read this technical document carefully to familiarize yourself with the product. Pay special attention to the information in this chapter.

2.1 Manufacturer

Manufacturer of the product is:

GfG Gesellschaft für Gerätebau mbH

Klönnestraße 99
44143 Dortmund
Germany

Phone: +49 231 564 00-0
Fax: +49 231 564 00-895
Email: info@gfg-mbh.com
Web: GfGsafety.com

If required, you will receive further information about the product and additional copies of this technical document from this address.

2.2 Disclaimer

All information and notes in this technical document have been compiled taking into account the applicable standards and regulations, current state of the art technology and our many years of knowledge and experience.

The manufacturer does not assume liability for damages due to:

- » the use of unauthorized accessories
- » the use of non-approved spare parts
- » technical modifications
- » failure to comply with these instructions
- » use not in accordance with the intended purpose
- » unauthorized modification
- » operation by employees without appropriate training or specialist knowledge

The obligations agreed in the delivery contract, the general terms and conditions and delivery conditions of the manufacturer as well as the legal regulations valid at the time of the conclusion of the contract shall apply.

2.3 Subject to alterations

The information contained in this technical document corresponds to the technical specifications released at the time of publication. Changes will be taken into account in a new edition of the operation manual.

Composition of the document number:

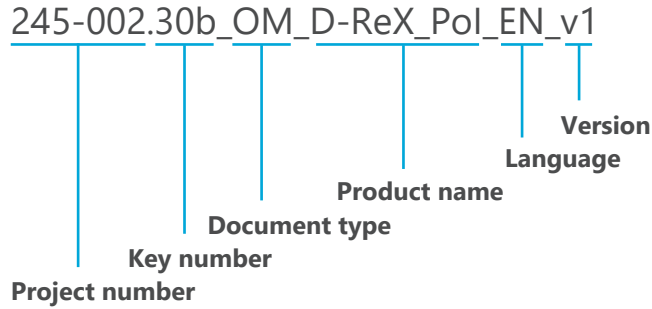

2.4 Place of storage

This document as well as any further applicable documents must be kept on hand and accessible at all times for later use.

2.5 Symbols in this manual

Safety instructions are identified by symbols in this manual. The safety instructions are introduced by a signal word expressing the extent of the hazard.



DANGER

Specific designation of the type of hazard
Behavior to avoid danger

This combination of symbol and signal word indicates an **imminently** hazardous situation which, if not avoided, will result in **death or serious injury**.



WARNING

Specific designation of the type of hazard
Behavior to avoid danger

This combination of symbol and signal word indicates a **potentially** hazardous situation which, if not avoided, could result in **death or serious injury**.

**CAUTION****Specific designation of the type of hazard**

Behavior to avoid danger

This combination of symbol and signal word indicates a **potentially** hazardous situation which, if not avoided, may result in **minor injury or moderate injury**.

**ATTENTION****Specific designation of the type of hazard**

Behavior to avoid danger

This combination of symbol and signal word indicates a **potentially** hazardous situation which, if not avoided, may result in **property damage**.

2.6 Safety information in handling instructions

Safety instructions may refer to individual instructions for action. Such safety instructions are embedded in the action instruction so that they do not interrupt the flow of reading while performing the action. The previously described signal words are used.

Example:

Contaminations on the device's exterior may be removed with a damp cloth. Do not use solvents or cleaning agents!



**ATTENTION****Possible damages to the D-ReX or sensor**

Solvents can damage the housing of the D-ReX. Some cleaning agents also contain ingredients which may act as sensor poisons and could thus affect the function and / or lifetime of the sensor!*

* This example refers to the manner of presentation and not the content of this technical document.

2.7 Warning signs used in this document

The following warning signs are used to draw attention to particular hazards in safety instructions:

Warning sign	Type of danger
	General warning sign
	Warning of dangerous electrical voltage
	Fire hazard

Tips and recommendations



This symbol highlights useful tips and recommendations as well as information for efficient and trouble-free operation.



Reference to another chapter in this document.

2.8 Other markings

The following paragraphs provide an overview of the spelling and abbreviations used in these operating instructions.

2.8.1 General notation

Within this document, certain information is highlighted by special notations to ensure better readability.

Notation	Usage	Example
VERSALIA	Hardware operating element	ON/OFF switch
<u>Underlined</u>	Software operating element	Press <u>Next</u> button
[Bracket]	Keyboard key	[ctrl] + [alt]
Bold	System notification	Alarm1 limit value exceeded
Text > Text	Menu path	Parameter > Control parameter
(▶ page page number)	Cross reference	(▶ page 23)
1. Text 1 2. Text 2	Step by step instructions	1. Disconnect mains plug 2. Remove housing cover. For this...
» ...	Enumeration without order	

2.8.2 Definition of terms

For better comprehension, some definitions of terms used in these operating instructions are listed below:

- » **Measured gas:** The gas or gas compound you are monitoring. It usually consists of air, the target gas and other components. In case of the D-ReX, it reaches the sensor by diffusion.
- » **Target gas:** Gaseous substance you are trying to detect in the measured gas and want to be warned of.
- » **Test gas:** Gas compounds of known composition used for calibration and adjustment of gas detection systems.
- » **Replacement test gas:** Gas/air mixture used as a substitute for difficult-to-handle gas.
- » **Zero gas:** Test gas that contains neither the target gas nor interfering impurities.
- » **Interfering gas:** A gas that causes the sensor to react even if the target gas is not present, or that falsifies the measurement result when target gas is present.
- » **Cross sensitivity:** It represents the sensitivity of a measuring device to quantities other than the measurand.
- » **Calibration:** Comparison of a gas detector's / sensor's displayed result with a known test gas concentration without adjusting.
Depending on the degree of deviation detected, the device:
 - » can continue to be operated within the permissible deviation from the set value
 - » must be adjusted
 - » must be repaired
- » **Adjustment:** Adjustments of the zero point and sensitivity of the gas detector / sensor with a known zero gas or test gas.

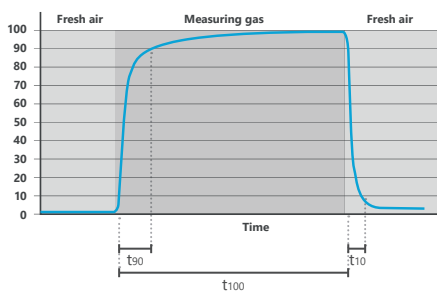

- » **Adjustment time:** The adjustment time **t₁₀₀** is the time span required by a measuring device to react to sudden changes in the value of the measurand with a corresponding change of the measuring signal. The change in measurement signal itself is not abrupt but rather follows the shape of a curve, which gradually approaches the target value. The shorter the adjustment time, the faster a transmitter will display the actual current concentration of a gas.

Since it takes a disproportionately long time to settle to the last 10 % accuracy both when rising and when falling, intermediate values such as **t₉₀**, **t₅₀** or, in the case of decreasing gas concentration, **t₁₀** are much more important. They provide significantly better response times with sufficient accuracy.

Detailed information on the **t₉₀** times of D-ReX sensors can be found in the sensors' data sheets.

- » **Non-latching alarm:** A non-latching alarm is reset automatically as soon as the target gas concentration falls back below (or, in case of O₂, rises above) alarm threshold 1. The assigned relays will also be deactivated.
- » **Latching alarm:** A latching alarm will stay active when the target gas concentration falls back below (or, in case of O₂, rises above) alarm threshold 1. It has to be reset manually. The assigned relays will stay active during this time.
- » **Occupational exposure limits (OEL):** The occupational exposure limit is the limit for time-weighted average concentrations of a substance in the ambient air at the workplace within a given reference time. It indicates the concentration of a substance up to which acute or chronic harmful effects on the health of employees are generally not to be expected. The occupational exposure limit is displayed in ml/m³ (ppm). The most common international occupational exposure limits include STEL (short-term exposure limit) and PEL (permissible exposure limit). In any case, the national guidelines of the country the device was installed in apply.
- » **STEL (short-term exposure limit):** The short-term exposure limit (STEL) is the permissible average exposure for a short time, usually 15 minutes, as long as the time-weighted average (TWA) is not exceeded.
- » **PEL (permissible exposure limit):** The permissible exposure limit (PEL or OSHA PEL) is a national limit value guideline in the United States which regulates the exposure of an employee to a chemical substance. PELs are usually given as time-weighted averages (TWA).
- » **TWA (time-weighted average):** The TWA value is the average exposure over a certain amount of time, usually eight hours. This means that a worker may be exposed to concentration levels above the PEL for limited periods of time as long as the TWA value is not exceeded. In many places, the term TWA is used as a synonym for the occupational exposure limits for times of up to eight hours.

2.8.3 Abbreviations and SI units

In In this document, abbreviations are shown and used in the same way as they are shown in the display for reasons of space. SI units are used according to international guidelines.

2.9 Intended use

The D-ReX PoI is an independent 1-gas detection system for DIN rail mounting in a control cabinet, in wall-mounted housing or on any suitable spot in indoor places. It is used for monitoring gas concentrations at the mounting location in diffusion mode.

It can monitor the oxygen concentration, toxic gases or combustible gases and vapors outside of Ex zones.



WARNING

Explosion hazard

The device may not be mounted in Ex zones!

The device must be mounted in a location with as little vibrations as possible.

When used as intended and according to the requirements and conditions specified in this technical document as well as the safety instructions in this technical document and on the product itself, the product poses no danger to people, property or the environment. This applies throughout its entire service life, from delivery, installation and operation to disassembly and disposal.

Adjustments in service mode may only be carried out by professionally qualified personnel. Any use beyond the intended use is considered misuse.

2.10 Due diligence of the operator

To avoid accidents, malfunctions and undue effects on the environment, those responsible for installation, operation, maintenance and disposal must ensure the following:

- » All safety instructions and hazard warnings must be observed
- » Employees are instructed regarding occupational safety and proper use of the product, especially with regards to the safety instructions in this operation manual
- » Regulations, operating instructions for safe handling and the instructions on staff behavior in case of alarms are kept easily accessible at all times. If necessary, that means posting them on the premises.
- » The product is only used in perfect, functional condition
- » The scheduled inspection intervals and maintenance cycles are adhered to.
- » Only spare parts and auxiliary materials approved by the manufacturer are used
- » The specified operating conditions and requirements regarding the installation location are observed
- » Installation, electrical connection and commissioning of the product are carried out exclusively by qualified, trained staff

The operator is responsible for ensuring that the product is used as intended.

3. Functional design

3.1 Control buttons and display

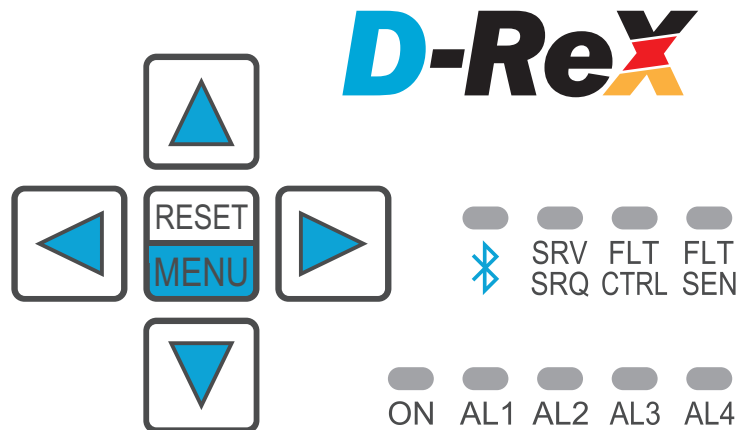

The following elements are located at the front of the D-ReX:

- » 5 control buttons
 - » Alarm acknowledgement and selection button RESET/MENU
 - » 4 arrow buttons for navigation (UP, DOWN, RIGHT, LEFT)
- » Status LED for Bluetooth
- » Status LEDs for operating conditions
- » Status LED for power supply
- » Status LEDs for alarms
- » a window to the sensor cartridge's label
- » Status LEDs for LAN connection

3.1.1 Control buttons

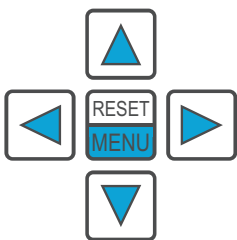

In measuring mode, use the control buttons to switch between different display presentations of the measured values or return to the overview. The RESET/MENU button is used for alarm acknowledgement and to enter the main menu.

Use the control buttons in the main menu and service menu to navigate the menus or adjust the settings.

For more detailed information, refer to section 5.1 Keypad and controls (► page 35)

3.1.2 Status-LEDs

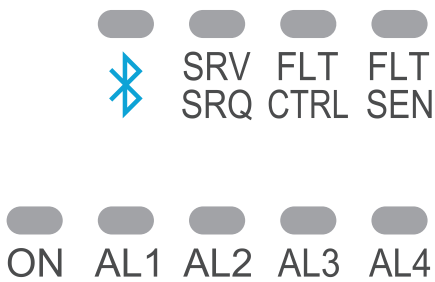

Status LED Bluetooth

The upper left LED is labeled with the Bluetooth symbol . It provides information on the status of the Bluetooth connection.

- LED off Bluetooth is deactivated in the settings
- LED flashes (blue) Bluetooth is activated in the settings
- LED is lit (blue) Active Bluetooth connection

Status LED Service

The second LED in the upper column is labeled SRV/SRQ. It informs you if the D-ReX is in service mode (SRV) or when servicing is overdue (service request – SRQ).

- LED off Normal operation
- LED flashes (yellow) Date for next servicing has been exceeded. The D-ReX will continue operating as usual.
- LED is lit (yellow) D-ReX is in service mode

Status LED Device error

The third LED in the upper column is labeled FLT/CTRL. It provides information on the status of the D-ReX.

- LED off Normal operation
- LED is lit (yellow) An error has occurred on the D-ReX

Status LED Sensor error

The fourth LED in the upper column is labeled FLT/SEN. It provides information on the status of the sensor and the sensor cartridge.

- LED off Normal operation
- LED is lit (yellow) An error has occurred during communication with the sensor

Status LED Power supply

The first LED in the lower column is labeled ON and indicates whether the D-ReX is being supplied with power (mains supply or Power over Ethernet, PoE)

- LED off no power supply
- LED is lit (green) Supply voltage is applied

Alarm LEDs 1 to 4

LEDs two to five of the lower column are labeled AL1 to AL4 and give information on whether any set alarm thresholds have been exceeded.

- All LEDs off Normal operation
- LED flashes (red) this alarm threshold was exceeded
- LED is lit (red) this alarm has been acknowledged, but the alarm threshold is still exceeded



If more than one alarm thresholds are exceeded, all corresponding LEDs will flash. Example: If **AL2** is exceeded, **AL1** will also continue flashing.

Additionally, information on the alarms is indicated on the display and the alarm status is highlighted by corresponding colors.



The alarms on the D-ReX can generally be configured freely and can be set to current values and average values. The alarm thresholds for alarm **AL1** and **AL2** are initially set automatically to the values stored in the D-ReX alarm table, which are based on health and safety regulations, as soon as a sensor is inserted and recognized.

For more information on setting alarms, refer to section 5.4.1.1.3 Alarms (► page 61)



Status-LEDs LAN

Two LAN status LEDs are located in the bottom left corner of the housing cover, above the RJ45 plug.

They correspond to the LEDs located on the RJ45 plug in regards to the information they supply. Since these are facing downwards on the D-ReX (and are also covered by the CAT cable), the information is additionally shown on the device's front.

The left LED is labeled LAN / 10/100.

LED off no LAN connection

LED is lit (green) LAN connection (usually 100 Mbit) active

The right LED is labeled LAN/ACT.

LED off no data transfer

LED flashes (green) data transfer active

3.1.4 Window to adapter cartridge



Label adapter cartridge

Below the display, there is a window allowing you to see the label of the inserted adapter cartridge.

3.1.5 TFT color display

The 2.4" (320 x 240 pixels) TFT color screen displays up to 16 million colors and information in clear text. Currently, information can be displayed in German or English. More languages will be added later.

Display of measured values

In normal operation, the measured values are displayed with the screen backlit in green.

The background's color will switch to orange or red in case of an alarm. The alarm's number, for example "ALARM 1" and the unit the gas is measured in are displayed in alternation.



CAUTION

Alarm's signal color depends on alarm number

Regardless of whether a measured value or an average value is used as an alarm threshold for Alarm 1, the background is always lit orange. On alarms 2 to 4, it will always be red.

The following information is also displayed:

- 1 Position of measured value:
Measured value position 1 is used as a default position for the sensor. The D-ReX Pol only uses one measured value position in general. Further information on this can be accessed via the main menu.
- 2 Designation of the measured value position:
The designation can be changed using the D-ReX configuration program.
- 3 Current measured value
- 4 Bar graph:
The current measured value is additionally displayed in a bar graph, using the percentage of the sensor's measuring range.
- 5 Alarm threshold markers:
Small triangles (▶) mark the set alarm thresholds. Up to 4 alarm thresholds can be set at a time.



Alarm thresholds for the target gas can be set either for when the measured value exceeds them (or, in case of O₂, falls below) or for time-weighted average concentrations (STEL / TWA). In case of time-weighted average alarms, the current gas value may exceed the nominal alarm threshold without triggering an alarm, since the average over time is still not critically dangerous.

- 6 Type of gas
- 7 Unit or Unit / Alarm number in alternation
- 8 [i] Info icon followed by a note on the error or operational status, e.g. **AL1**, **AL2** or **FLT**, **Start up**.

Actions:



Control button RIGHT:
Switch to overview:



Why are measured value positions necessary?

As an example, the D-ReX PoS (Point of Sampling) with its integrated pump uses different measured value positions to monitor the status of the pump and the pressure inside the intake hose.

An overview as well as a measured value view is available for each measured value position.

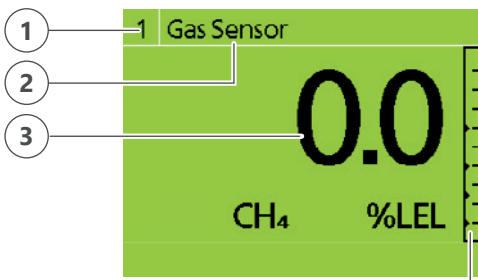

Pol display of measured values

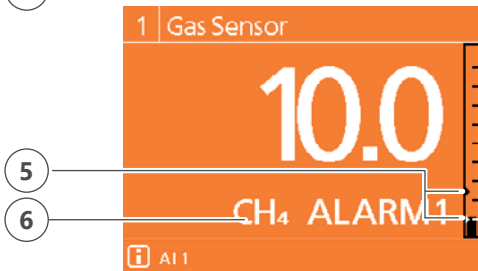

View Alarm 1

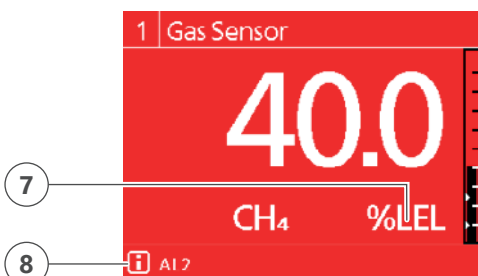

View Alarm 2 to 4

Gas	0.0	CH ₄ %LEL
1 Sensor		
Pump	0.50	Q slpm
2 Gas flow		
Pump	-0.12	P kPa
3 Line integrity		
Pump	65%	
4 Power		

Measured value positions PoS

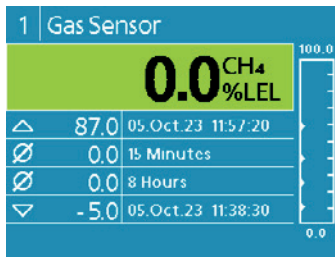

Overview

Overview

In the overview, the current measured value is also backlit green in normal operation. If it exceeds an alarm threshold, the green bar will turn either orange or red, depending on the triggered alarm.

The following information are also displayed in this view:

- 1 Measured value position
- 2 Designation of measured value position
- 3 Current measured value
- 4 Lower and upper values of the measuring range; in this example: 0-100 % LEL
- 5 Bar graph
- 6 Alarm threshold markers
- 7 Maximum value with time stamp since system start-up or last reset of the value
- 8 Average value (TWA), e.g. 15 minutes (time frame can be adjusted)
- 9 Average value (TWA) e.g. 8 hours (time frame can be adjusted)
- 10 Minimum value with time stamp since system start-up or last reset of the value

Control button RIGHT:



Hold down for 3 seconds to set the minimum and maximum value to zero or respectively reset the current gas concentration. The previous values cannot be restored or displayed after this.



Control button LEFT:
Switch to measured value view

3.2 Visual and acoustic alarms

The D-ReX will warn you visually by changing its display color from green to orange or red (► page 21) and by the respective error or alarm LEDs being lit up.

An acoustic and additional visual alarm can be triggered either via the internal relays (optional) or an external relay module (GMA200-RT or GMA200-RTD).

More detailed information on the different alarms can be found in section 5.4.1.1.3 Alarm configuration (► page 64).

3.3 Digital RS-485 interface

The D-ReX features two useable, digital RS-485 interfaces, Modbus 2 and Modbus 3. Modbus 1 is used for internal communication of the D-ReX.

Modbus 2 (middle terminal block X71 to X73) is used for connecting a type GMA200-RT or GMA200-RTD external relay module to the D-ReX. Both relay modules will give you access to an additional 16 relays.

Modbus 3 (left terminal block X66 to X68) is used for connecting the D-ReX to, for example, a PLC.

3.4 Relais

3.4.1 Internal relays (optional)

The D-ReX is optionally also available with five internal relays with one floating changeover contact each (max. 3 A / 30 V DC or min. 10 mA / 5V) for transmitting information on exceeded thresholds as well as fault and maintenance notifications.

All relays can be configured freely, with the exception of one relay having to be configured as a fault relay and one as a service relay. You can either use a separate relay for this purpose or configure the alarm relay as a combined alarm / service relay.



More detailed information on the internal relays can be found in section 5.3.2.3 Main menu > Info relays (► page 52).

If the internal relays are not sufficient for the safety concept you are planning, an additional external relay module can also be connected.

3.4.2 External relay module (optional)

The D-ReX can be expanded by 16 freely configurable relays with one floating changeover contact each by connecting either a GMA200-RT or GMA200-RTD (D = comes with its own display and control buttons) external relay module.

They are connected via the RS-485 interface. The relay module can be located up to 1200 m away from the D-ReX itself. Data is typically transferred with cycle time of 1.0 sec. In case of temporary disruptions, the relay module's reaction time may increase to up to <4 sec.

If data transmission to the relay is disrupted for longer amounts of time, the D-ReX will indicate a fault, beginning with the third consecutive faulty data transmission.

The relay modules are not part of this operation manual. For further information, please refer to operation manual GMA200-RT/RTD (222-000.24_BA_GMA200-RT).

3.4.3 Configuration of the relays

The internal relays are configured using the DReX-Config software. It offers extensive options to assign the relays to alarm functions and measuring points or measurement groups.

Configuration options:

- » Open circuit principle / Closed circuit principle
- » Single alarms per measuring point and alarm threshold
- » Collective or group alarms
- » Fault notifications
- » Configuration of And/Or connections

Internal relays

Common Online Data

Relay	Description (text)	Functionality	Inhibition	Operation principle	Voting	Measurement value assignment
1	Alarm 1	AL1	<input type="checkbox"/>	Open-circuit	Off	1 <input checked="" type="checkbox"/>
2	Alarm 2	AL2	<input type="checkbox"/>	Open-circuit	Off	1 <input checked="" type="checkbox"/>
3			<input type="checkbox"/>	Open-circuit	Off	1 <input checked="" type="checkbox"/>
4	Service	SRV-SEN,SRV-CTRL	<input type="checkbox"/>	Open-circuit	Off	1 <input checked="" type="checkbox"/>
5	Fault	FLT-SEN,FLT-CTRL	<input type="checkbox"/>	Closed-circuit	Off	1 <input checked="" type="checkbox"/>

- AL1 (Alarm 1)
- AL2 (Alarm 2)
- AL3 (Alarm 3)
- AL4 (Alarm 4)
- FLT-SEN (Sensor Fault)
- FLT-CTRL (Control Fault)
- SRV-SEN (Sensor Service)
- SRV-CTRL (Control Service)
- SRQ-SEN (Sensor - Service request)
- SRQ-CTRL (Control - Service request)
- LON (Control by LON)
- RESET (Acknowledgeable horn)

The DRex-Config software is also used to configure the communication with the external relay module.

External relay module

Common

Module	Activation	Description	Connection	Type	Timeout	State after timeout
1	<input checked="" type="checkbox"/>	Relaismodul	Modbus 2(Addr. 1)	GMA200RT	00:00:00	Logic on

- Without current
- Maintain
- Logic on
- Logic off

The 16 additional relays are still configured using the GMA200-Config software.

3.5 Analog outlet

The D-ReX has an analog 4-20 mA outlet which emits a voltage proportional to the measured value. This analog signal can be further processed by superordinate control systems, since the measured value is already linearized.

The following table lists output currents and their corresponding D-ReX status.

Output current	Status in measuring mode and special statuses
approx. 0.0 mA	no active measuring point assigned
approx. 0.0 mA	D-ReX in start-up phase
approx. 0.0 mA	D-ReX in fault condition (influencing the measuring points measuring ability)
1.2 mA	assigned measuring point in fault condition
1.6 mA	assigned measuring point in start-up
2.0 mA	D-ReX in configuration mode (maintenance)
2.4 mA	assigned measuring point in maintenance mode
2.8 mA	measured value $\leq -7.5\%$ of the measuring range (if Clamping* is not active)
2.8 to 4.0 mA	measured value $\leq 0\%$ of the measuring range (if Clamping* is not active)
4.0 mA	measured value $\leq 0\%$ of the measuring range (if Clamping* is active)
4.0 to 20 (22) mA	measured value 0 to 100 (112.5) % of the measuring range
22.0 mA	measured value $\geq 112.5\%$ of the measuring range
Manual specification	Test mode active (maintenance)

* Clamping prevents the output current from becoming < 4 mA in measuring mode for measured values below the measuring range. Without this in place, problems could arise for interactions with PLCs. Clamping can be activated and deactivated using the DReX-Config software.

3.6 Sensors

The D-ReX exclusively uses smart sensors. In this case, “smart” means:

- » The D-ReX sensors come with their own memory chip (EEPROM) which is used for storing individual information, such as the serial number, production date, look-up tables for measured value compensation or coefficients for calculations.
- » The D-ReX sensors are pre-calibrated and pre-adjusted. This information, as well as further related parameters, are also stored on the EEPROM and can be read out by the D-ReX. The sensors are thus ready to be used immediately.
- » If you receive D-ReX sensors and a sensor cartridge collectively, the sensors and cartridge will have been adjusted and calibrated together.
- » The D-ReX will configure itself according to the sensor’s data. Each D-ReX is thus able to measure every gas.
- » The only exceptions to this are gases which need an additional pyrolyzer to be detected and must therefore be drawn in. These can only be monitored with a combination of pyrolyzer and D-ReX PoS (Point of Sampling).
- » To replace a sensor, only the sensor itself has to be switched out, not the entire cartridge. You can continue to use the same sensor cartridge, reducing both costs and the amount of electronical waste.
- » To change the monitored type of gas, you simply replace the sensor or insert a new sensor cartridge with appropriate new sensors into the D-ReX.



ATTENTION!

Interaction between sensor cartridge and sensor

Even if the D-ReX sensors are ready to use upon delivery, we recommend adjusting and, if necessary, calibrate them (and the sensor cartridge) before commissioning. There might be minor deviations regarding readouts. For sensors which are delivered in combination their sensor cartridge, this step is not necessary. Adhere to any national regulation or internal business guidelines deviating from this recommendation and specifying that this check as mandatory instead.

3.6.1 Smart electrochemical sensors (EC)

The D-ReX' EC sensors are used in combination with the internal sensor cartridge for EC/IR/PID sensors (item no. 3601001). Refer to the table below for a list of available sensors sorted by gases

Smart EC Sensors

Gas	Formula	Measuring range	Type	Item no.
Ammonia	NH ₃	0-100 ppm	MK393-10	3600068
Ammonia	NH ₃	0-1000 ppm	MK399-10	3600069
Ammonia	NH ₃	0-5000 ppm	MK455-10	3600070
Arsine	AsH ₃	0-1 ppm	MK482-10	3600040
Arsine	AsH ₃	0-1 ppm (no cross-sensitivity to H ₂)	MK483-10	3600041
Bromine	Br ₂	0-5 ppm	MK474-11	3600048
Hydrogen bromide	HBr	0-30 ppm	MK479-11	3600061
Chlorine	Cl ₂	0-10 ppm	MK474-10	3600053
Chlorine dioxide	ClO ₂	0-2 ppm	MK391-10	3600055
Chlorine trifluoride	ClF ₃	0-1 ppm	MK391-11	3600086
Hydrogen chloride	HCl	0-30 ppm	MK479-10	3600062
Hydrogen cyanide	HCN	0-30 ppm	MK409-10	3600064
Diborane	B ₂ H ₆	0-1 ppm	MK484-10	3600043
Dichlorosilane	DCS	0-30 ppm	MK479-12	3600078
Ethylene oxide	ETO	0-20 ppm	MK452-10	3600085
Fluorine	F ₂	0-5 ppm	MK414-10	3600087
Hydrogen fluoride	HF	0-10 ppm	MK475-10	3600066
Germanium	GeH ₄	0-5 ppm	MK484-10	3600088
Hexamethyl disilazane	HMDS	0-0.5 vol %	MK399-11	3600092
Hydrazine	N ₂ H ₄	0-1 ppm	MK486-10	3600090
Carbon monoxide	CO	0-500 ppm	MK443-10	3600050
Ozone	O ₃	0-1 ppm	MK411-10	3600073
Ozone	O ₃	0-5 ppm	MK473-10	3600074
Phosgene	COCl ₂	0-2 ppm	MK349-10	3600052
Phosphine	PH ₃	0-1 ppm	MK478-10	3600075
Oxygen	O ₂	0-25 vol % (5-year sensor, lead-free)	MK466-10	3600071
Sulfur dioxide	SO ₂	0-10 ppm	MK480-10	3600080
Hydrogen sulfide	H ₂ S	0-100 ppm	MK445-10	3600059
Hydrogen selenide	H ₂ Se	0-5 ppm	MK485-10	3600089
Silane	SiH ₄	0-50 ppm	MK477-10	3600079
Nitrogen	NO	0-100 ppm	MK456-10	3600093
Nitrogen dioxide	NO ₂	0-30 ppm	MK459-10	3600095
Tetraethyl orthosilicate	TEOS	0-100 ppm	MK481-10	3600081
Trimethylborate	TMB	0-500 ppm	MK481-11	3600082
Hydrogen	H ₂	0-2000 ppm	MK401-10	3600056
Hydrogen	H ₂	0-1 vol %	MK402-10	3600057
Hydrogen	H ₂	0-4 vol %	MK403-10	3600058

3.6.2 Smart Infrared sensors (IR)

The D-ReX' IR sensors are used in combination with the internal sensor cartridge for EC/IR/PID sensors (item no. 3601001). Refer to the table below for a list of available sensors sorted by gases.

Smart IR Sensors

Gas	Formula	Measuring range	Type	Item no.
Nitrous oxide	N ₂ O	0-1000 ppm	MK262-10	3600210
Nitrous oxide	N ₂ O	0-1 vol %	MK263-10	3600211
Carbon dioxide	CO ₂	0-5 vol %	MK250-10	3600200
Carbon dioxide	CO ₂	0-1 vol %	MK251-10	3600201
Methane	CH ₄	0-5 vol %	MK254-10	3600205
Propane	C ₃ H ₈	0-2 vol %	MK253-10	3600206

3.6.3 Smart catalytic sensors (CC)

The D-ReX' CC sensors (also called pellistor) are used in combination with the internal sensor cartridge for CC sensors (item no. 3601002). Refer to the table below for a list of available sensors sorted by gases.

Smart CC Sensors

Gas	Formula	Measuring range	Type	Item no.
Acetylene	C ₂ H ₂	0-100 % LEL	MK221-10	3600156
Butane	C ₄ H ₁₀	0-100 % LEL	MK221-10	3600153
Ethane	C ₂ H ₆	0-100 % LEL	MK221-10	3600158
Ethylene	C ₂ H ₄	0-100 % LEL	MK221-10	3600157
Hexane	C ₆ H ₁₄	0-100 % LEL	MK221-10	3600155
Methane	CH ₄	0-100 % LEL	MK221-10	3600150
Pentane	C ₅ H ₁₂	0-100 % LEL	MK221-10	3600154
Propane	C ₃ H ₈	0-100 % LEL	MK221-10	3600152
Hydrogen	H ₂	0-100 % LEL	MK221-10	3600151

3.6.4 Advanced sensor data



For further information and specifications, please refer to the sensor data sheet.

3.7 Accessories (optional) and spare parts

We offer several complementary accessories and spare parts for the D-ReX.

Accessory	Item no.
Replacement D-ReX bayonet lock for internal sensor cartridges	3601000
Internal sensor cartridge for EC/IR/PID sensors, without sensor	3601001
Internal sensor cartridge for CC sensors, without sensor	3601002
Calibration adapter with O-rings for internal sensor cartridges	3604040
D-ReX lower housing cover for D-ReX Pol or Pol (diffusion)	3604200
DIN rail for D-ReX or Py-ReX 35/7.5 Length 500 mm	3605101

4. Mounting and installation

4.1 Mounting location

The D-ReX is intended for DIN rail mounting (TH35, previously TS35), according to DIN EN 60715, in altitudes of up to 2000 meters above sea level. Installations in suitable wall-mounted housings and control cabinets are also included in this. Versions with an increased IP protection class (IP64), may also be mounted outside. Additional protection measures both for the device and sensor may be necessary in this case.



WARNING

Explosion hazard

The device may not be mounted in Ex zones!
It is approved only for use outside of Ex zones.



CAUTION

Defects caused by mechanical vibrations

Mount the D-ReX in a way that prevents exposure to mechanical vibrations.



CAUTION

Airflows falsifying the measured values

When choosing a suitable location, consider if there are any permanent or temporary airflows in the area.

The D-ReX Pol works in diffusion mode.

Consider the following factors when choosing a suitable location:

- » the density of the target gas
- » Potential permanent or temporary airflows

If the target gas is lighter than air, the device has to be mounted above a possible emission point or in a spot where the target gas can accumulate (e.g. on the ceiling).

If the target gas is heavier than air, the device has to be mounted below a possible emission point or in a spot where the target gas can accumulate (usually close to the floor).

If the D-ReX is mounted close to the floor, take appropriate measures to protect the sensor from dirt and moisture.

If you are monitoring breathable air for its oxygen content, the device is usually mounted at a height corresponding to the average breathing zone. If the oxygen concentration is monitored for other reasons, the location is chosen based on requirements of the specific application.

4.2 Mounting the housing

Mount the DIN rail the D-ReX is attached to horizontally, so the connectors and sensor opening of the device point down when the D-ReX is mounted.

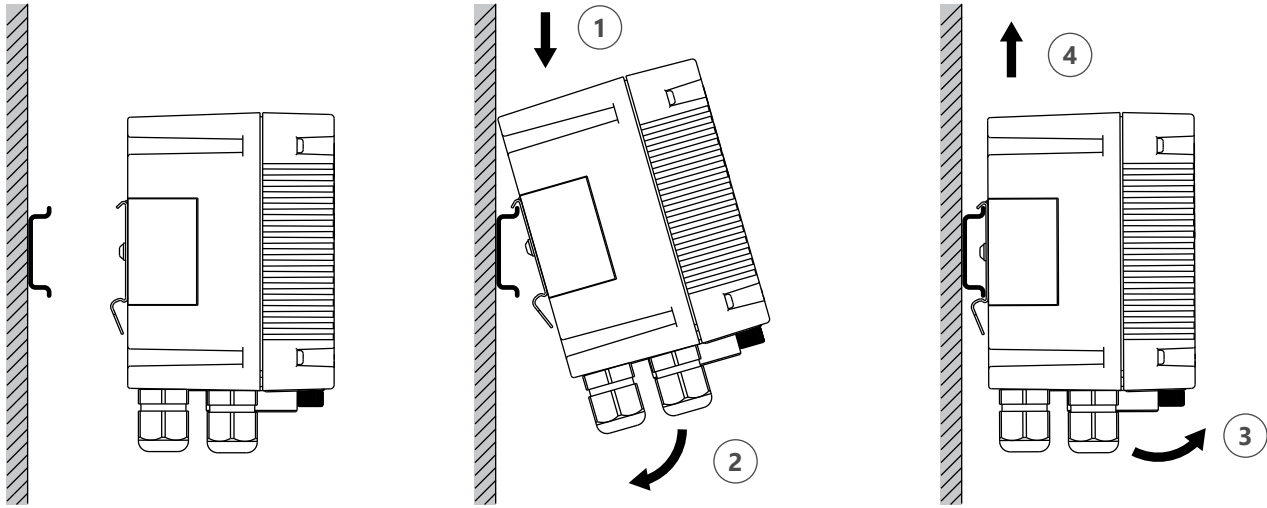

Mounting the device:

- » Hook the D-ReX onto the DIN rail at its clip (1)
- » Gently press down on its lower edge until it clicks into place (2).

Removing the device:

- » Grasp the bottom of the D-ReX and gently pull it out of the DIN rail (3).
- » Then, pull it upwards to remove it (4).

4.3 Attaching the sensor cartridge using a mounting bracket

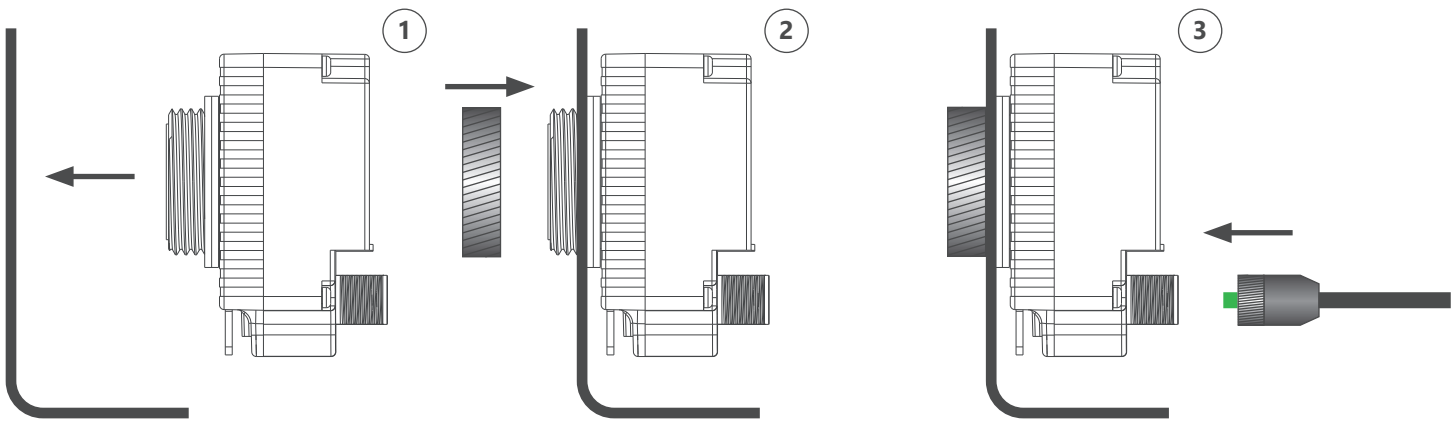

Attaching the cartridge:

- » Determine a suitable location for monitoring the gas.
- » Mount the mounting bracket in this location.
- » The sensor cartridge's sensor outlet has to face down or toward the front.
- » Insert the sensor cartridge via the mounting bracket's inlet (1) and fasten it with the nut (2).
- » Attach the cable to the sensor cartridge (3).

Removing the cartridge:

To remove the sensor cartridge, follow the steps in reverse order:

- » Remove the cable from the sensor cartridge.
- » Unscrew the nut and pull the sensor cartridge out through the mounting bracket's inlet.

4.4 Attaching the sensor cartridge on the mounting saddle

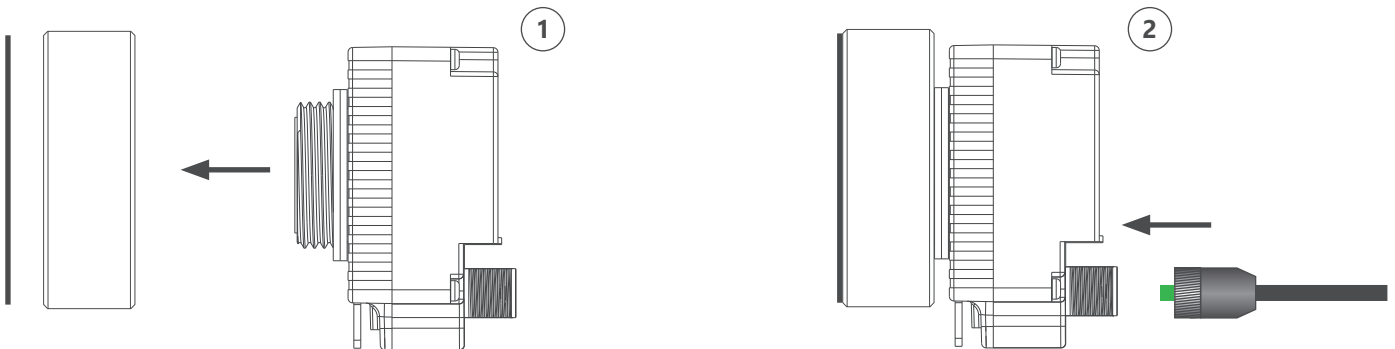

Attaching the cartridge:

- » Determine a suitable location for monitoring the gas.
- » Mount the mounting saddle in this location.
- » Screw the sensor cartridge onto the mounting saddle (1).
- » Attach the cable to the sensor cartridge (2).

Removing the cartridge:

- » To remove the sensor cartridge, follow the steps in reverse order:
- » Remove the cable from the sensor cartridge.
- » Unscrew the sensor cartridge from the mounting saddle.

4.5 Electrical connections



CAUTION

Defects caused by faulty electrical installation

Adhere to DIN VDE 0100 or the corresponding national guidelines when installing the device.

The cables used must be suitable for the intended application. Insulated wires and cables must be flame retardant.

All overcurrent protection devices (fuses, circuit breakers) of the electrical circuit must fulfill the standard requirements of installations inside buildings.

4.5.1 Current supply

An external 24 V DC power supply provides the current for the D-ReX. This current is connected to the X61 (GND) and X62 (Ub1 – 24 V DC) terminals. Optionally, a second 24 V DC power supply can be connected to the X63 (Ub2 - 24 V DC) and X64 (GND) terminals for redundant power supply.

The 24 V DC supply must be either a regulated safety extra-low voltage (SELV) or a protective extra-low voltage (PELV). The power of the power supply units must be sufficient for the D-ReX and any other supplied components.

4.5.2 Terminal assignment plan – connecting the device

All connections (power supply, communication, relays) have to be made according to the terminal assignment diagram.

Plug the cables into their corresponding terminals (1), taking care not to insert them perpendicularly, but at an angle (approx. 45°), as shown in the image below. To remove a cable, hold down the locking mechanism with a small screwdriver (2) and pull out the cable (at an angle as well) (3).

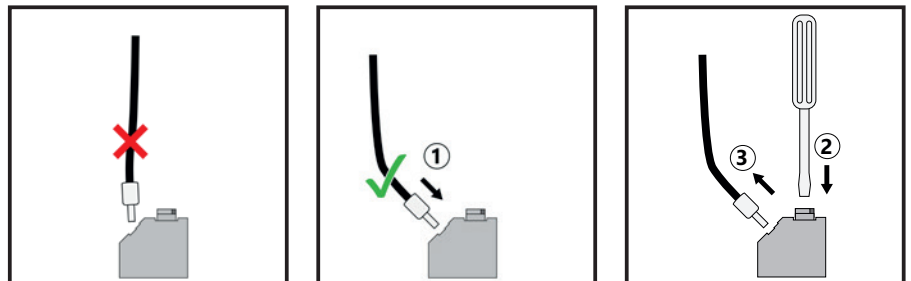

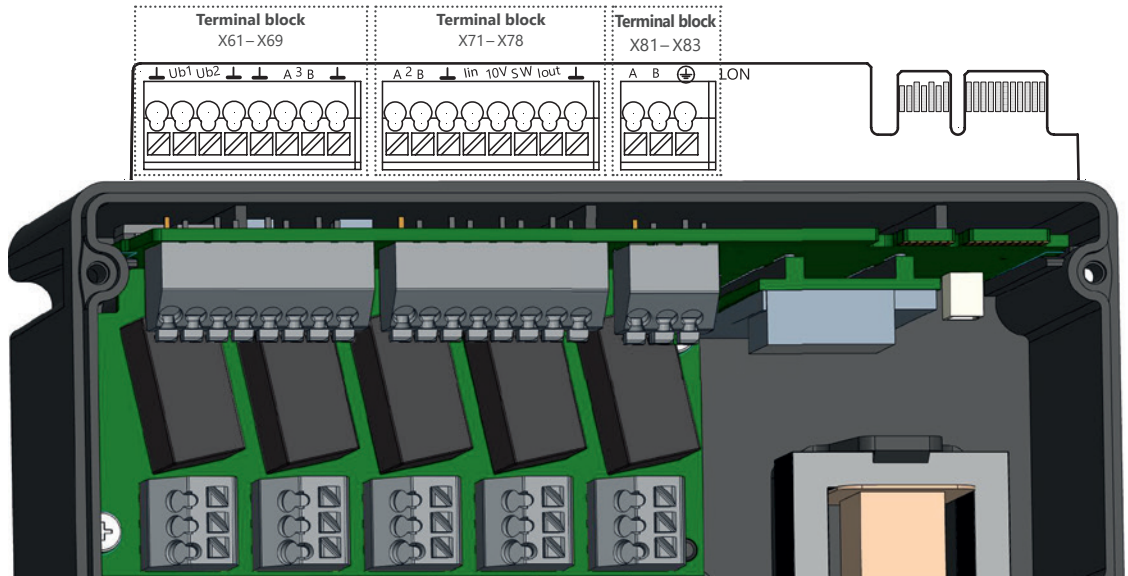

Left terminal block

No.	Abbreviation	Description	Note
X61	GND	Ground	Current supply 1 (SELV/PELV)
X62	Ub1	Power supply input 1– 24 V DC (20 bis 30 V DC)	
X63	Ub2	Power supply input 2– 24 V DC (20 bis 30 V DC)	Current supply 2 (SELV/PELV)
X64	GND	Ground	
X65	GND	Ground	
X66	A 3 (D1+)	Modbus 3 (RS485)	e.g. for connecting to a PLC
X67	B 3 (D0-)	Modbus 3 (RS485)	
X68	GND	Ground	

Center terminal block

No.	Abbreviation	Description	Note
X71	A 2 (D1+)	Modbus 2 (RS485)	e.g. for connecting an external relay GMA200-RT/RTD
X72	B 2 (D0-)	Modbus 2 (RS485)	
X73	GND	Ground	
X74	lin	4– 20 mA, input	for lout of the Py-ReX
X75	10V DC	10 V DC, max. 0.5 A	10 V DC, max. 0.5 A
X76	SW	reserve	
X77	lout	4– 20 mA, output	for signal evaluation
X78	GND	Ground	

Right terminal block

No.	Abbreviation	Descriptions	Note
X81	A	LON A	Connection of the LONWorks network
X82	B	LON B	
X83	SHLD	Shield	

Current supply 4– 20 mA current output

A freely configurable 4-20 mA current output (lout) is located at terminals X77 (see table and fig. above). This outlet can be connected to a recorder or external recording device against GND. Terminal X78 is recommended as GND.

4.5.3 Terminal assignment plan – relays

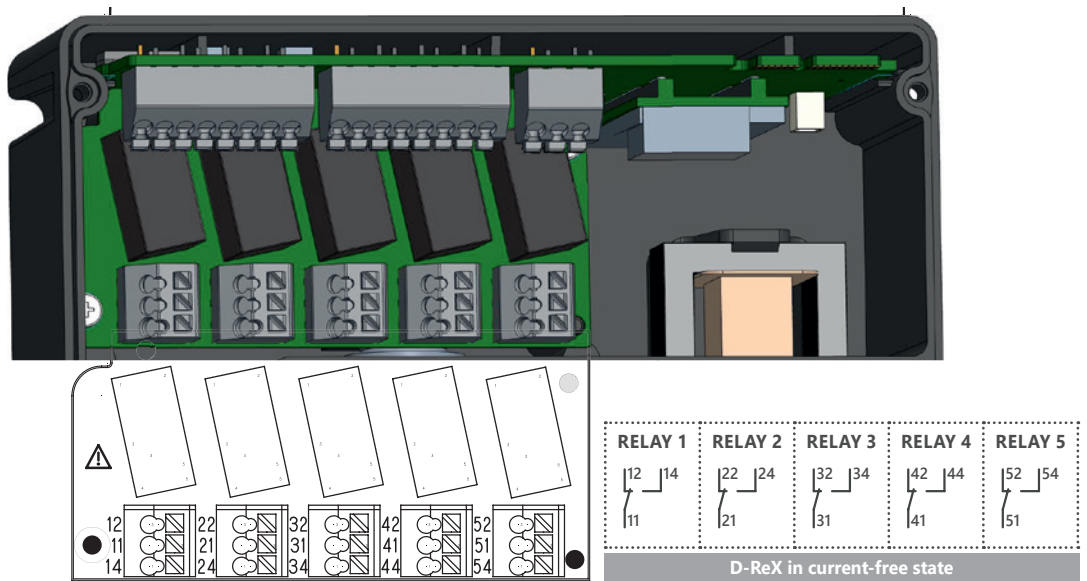

Terminal block relays 1

No.	Abbreviation	Description	Note
X12	12	Relay 1 NC contact	NC (de-energized)
X11	11	Relay 1 switching output	COM max. 30 V DC/ 3 A (min. 10 mA/ 5 V)
X14	14	Relay 1 NO contact	NO (de-energized)

Terminal block relays 2

No.	Abbreviation	Description	Note
X12	22	Relay 2 NC contact	NC (de-energized)
X11	21	Relay 2 switching output	COM max. 30 V DC/3 A (min. 10 mA/5 V)
X14	24	Relay 2 NO contact	NO (de-energized)

Terminal block relays 3

No.	Abbreviation	Description	Note
X12	32	Relay 3 NC contact	NC (de-energized)
X11	31	Relay 3 switching output	COM max. 30 V DC/3 A (min. 10 mA/5 V)
X14	34	Relay 3 NO contact	NO (de-energized)

Terminal block relays 4

No.	Abbreviation	Description	Note
X12	42	Relay 4 NC contact	NC (de-energized)
X11	41	Relay 4 switching output	COM max. 30 V DC/3 A (min. 10 mA/5 V)
X14	44	Relay 4 NO contact	NO (de-energized)

Terminal block relays 5

No.	Abbreviation	Description	Note
X12	52	Relay 5 NC contact	NC (de-energized)
X11	51	Relay 5 switching output	COM max. 30 V DC/3 A (min. 10 mA/5 V)
X14	54	Relay 5 NO contact	NO (de-energized)

4.6 Commissioning

Commissioning can be carried out after the D-ReX, including all add-ons as well as any applicable additional control modules have been installed and the power supply has been ensured. Gas detection devices must be tested for proper functioning by a qualified person according to national guidelines after their installation but before putting them in operation (initial commissioning).

In Germany, the applicable regulations are "DGUV Information 213-056 (Leaflet T 021 Section 8.1)" and "DGUV Information 213-057 (Leaflet T 023 Section 8.1)". You must also adhere to the corresponding standards and regulations of the country the D-ReX is installed in.

5. Operation instructions

5.1 Keypad and operation

The D-ReX has five operating buttons



RIGHT



LEFT



UP



DOWN



RESET/MENU

In measuring mode as well as in the main menu or service menu, the buttons have the following functions:

- » The UP and DOWN buttons are used to navigate upwards and downwards.
- » When entering characters, they allow you to scroll through all available characters (forwards and backwards respectively).
- » When entering values, they allow you to scroll through all available values (forwards and backwards respectively).
- » The RIGHT and LEFT buttons are used to navigate up or down one level of detail.
- » When entering characters, they allow you to move to the next or previous position.
- » When entering values, they allow you to move to the next or previous value.

Special feature

- » Hold down the RIGHT button for 3 seconds in the overview to set the maximum value and minimum value to the current value and begins a new monitoring period. The previous maximum and minimum value are not saved.

The function button RESET/MENU has the following functions, depending on the D-ReX' operation status and current menu:

Operation status	Action	Function
Measuring mode	Hold down for 3 s	Activates the main menu
Alarm	Press	Acknowledges latching alarms Deactivates the acoustic alarm* for non-latching alarms
Main menu	Press	confirms entered character or values and moves to next position / confirms your entry
Service Menu	Press	confirms entered characters and values and moves to next position / confirms your entry

* An acoustic alarm can only be actuated via an external buzzer which is connected to a relay.

5.2 Measuring mode

For most sensors, the D-ReX' normal measuring mode begins 60 seconds after switching on the power supply.

Sensors with a bias, such as the ethylene oxide sensor (ETO) or the oxygen sensor (O₂) *, will need a significantly longer adjustment time of up to 15 minutes.

The exact time of the start-up process therefore depends on the sensor you are using and the amount of time the D-ReX or sensor were turned off.

* While the oxygen sensor is ready to monitor after at most 15 minutes, depending on how long was turned off, it may still take a while to indicate a stable value. Adjust or calibrate the sensor only after it has been showing a stable value for some time.

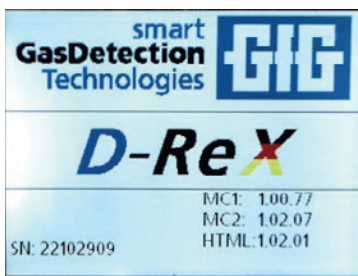

Starting screen

You will be greeted with a starting screen containing the following information:

- » Firmware version of the microcontrollers 1 (MC1)
- » Firmware version of the microcontrollers 2 (MC2)
- » Firmware version HTML software (HTML)
- » Serial number of the D-ReX

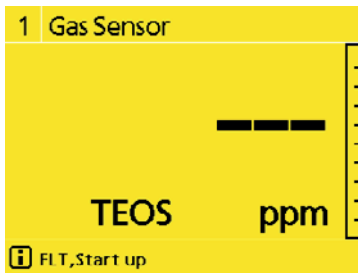

Start-up screen

Shortly after, the D-ReX will switch to a start-up screen containing the following information:

- » Measured value position
- » Designation of measured value positions
--- in place of the current measured value
- » Bar graph with no markers for alarm threshold set yet
- » Type of gas
- » Unit
- » [i] Info icon followed by a message regarding the operation status, in this case: **FLT, Start-up**



Sensor

During the warm-up phase, the FLT/SEN-LED will light up yellow. This is not indicating a fault but only shows that the sensor is not yet ready for operation.

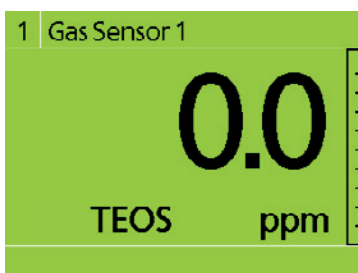

Measured value view

As soon as the start-up phase is completed, the device will switch to measured value view.

Actions:

-  RIGHT button:
Switch to overview:

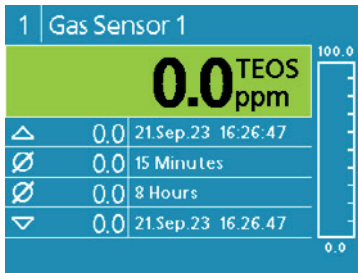

Overview

The overview shows not only the current measured value, but also the maximum and minimum value since the system was started up (or since the last reset) as well as two averaged measured values (usually for eight hours and 15 minutes).

Actions:



Hold down RIGHT button for 3 seconds:
Set the maximum value and minimum value to the current measured value. Previous values cannot be recovered or be displayed after this.



LEFT button:
Switch to measured value view

5.3 Main menu

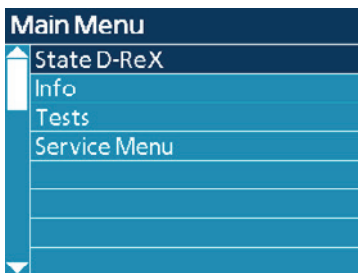

Main menu

The main menu contains a variety of system settings. It also allows you to trigger various system tests and lets you switch to the service menu.



To enter the main menu, hold the RESET/MENU button for 3 seconds while in measured value view or the overview.

The following menu items are available from the main menu:

- State D-ReX
- Info
- Tests
- Service menu

Actions:



DOWN button
Scroll down through the menu



UP button
Scroll up through the menu



RIGHT button:
Open the highlighted menu



RESET/MENU button:
Open the highlighted menu



LEFT button:
Back to measured value view

5.3.1 State D-ReX

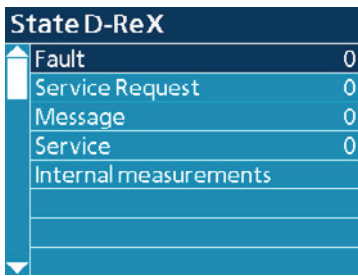

State D-ReX

The following items are available in the State D-ReX menu:

- Fault
- Service request
- Message
- Service
- Internal measurements

The numerical value behind the first four menu items ("0" in the adjacent image) indicates the number of active notifications of the individual menus.

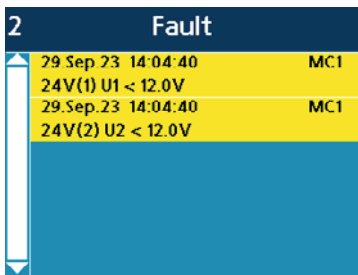

Example Fault notification

Actions:



DOWN button
Scroll down the screen



UP button
Scroll up the screen



RIGHT or RESET/MENU button:
 » If there are notifications available, display notifications
 » Display internal measurements



LEFT button:
Back to main menu

If there are no active notifications, this menu item cannot be displayed.

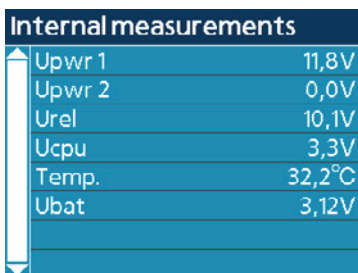

Internal measurements

The internal measurements view can always be accessed. It contains the following information:

- Upwr1** Power supply voltage 1 (X61/X62)
- Upwr2** Power supply voltage 2 (X63/X64)
- Urel** Relay voltage
- Ucpu** CPU voltage
- Temp.** Temperature inside D-ReX
- Ubat** Battery Voltage
(The battery supplies the D-ReX' internal clock with power while it is switched off)

5.3.2 Info

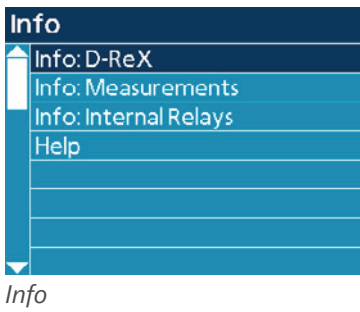

The Info menu contains the following items:

- Info: D-ReX
- Info: Measurements
- Info: Internal relays
- Help

Actions:



DOWN button
Scroll down through the menu



UP button
Scroll up through the menu



RIGHT or RESET/MENU button:
Select menu item



LEFT button:
Back to the main menu

5.3.2.1 Info: D-ReX

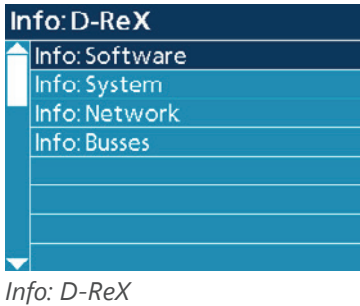

The Info: D-ReX menu contains the following items:

- Info: Software
- Info: System
- Info: Network
- Info: Busses

Actions:



DOWN button:
Scroll down through the menu



UP button:
Scroll up through the menu



RIGHT or RESET/MENU button:
Select menu item



LEFT button:
Back to the main menu

5.3.2.1.1 Info: Software

Info: Software	
Bootloader MC1:	1.00.03
Bootloader MC2:	1.00.03
Firmware MC1:	1.00.77
Firmware MC2:	1.02.07
HTML Version:	1.2.1
Firmware Sensor	1.07.17
Bootloader Sensor	0.05.03
Firmware LON	---

Info: Software

The Info: Software menu informs you about each software’s current version number.

It contains the following information:

- Bootloader MC1: & version number**
- Bootloader MC2: & version number**
- Firmware MC1: & version number**
- Firmware MC2: & version number**
- HTML version: & version number**
- Firmware sensor & version number**
- Bootloader sensor & version number**
- Firmware LON (LonWorks module) & version number**

The firmware version number of the LonWorks module is only displayed if the D-ReX contains a LonWorks module.

Action:



LEFT button:
Back to Info: D-ReX

5.3.2.1.2 Info: System

Info: System	
SN:	22102909
MAC:	A0:19:B2:60:00:79

Info: System

The Info: System menu gives you an overview about the D-ReX’ serial number and the set MAC address (Media-Access-Control).

It contains the following information:

- SN: & serial number**
- MAC: & MAC address**

Actions:



LEFT button:
Back to Info: D-ReX

5.3.2.1.3 Info: Netzwerk

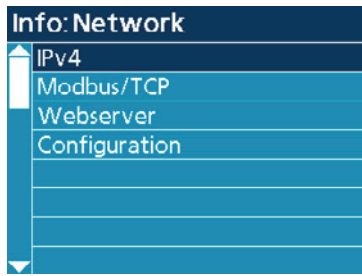

Info: Network

The Info: Network menu contains the following menu items:

- IPv4
- Modbus/TCP
- Webservice
- Configuration

Actions:



DOWN button
Scroll down through the menu



UP button
Scroll up through the menu



RIGHT or RESET/MENU button:
Select menu item



LEFT button:
Back to Info: D-ReX

5.3.2.1.3.a IPv4

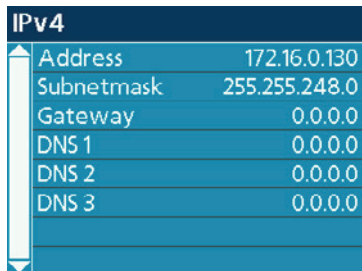

State IPv4

The IPv4 menu gives an overview of all network settings. It displays the following information:

- Address (network address) & set value**
- Subnet mask & set value**
- Gateway & set value***
- DNS 1 & set value ***
- DNS 2 & set value***
- DNS 3 & set value***

* Support for requests concerning the Domain Name System (DNS) are currently in development.

If you need this feature for your network, please contact GfG.

Actions:



LEFT button:
Back to Info: Network

5.3.2.1.3.b Modbus/TCP

Modbus/TCP	
Status	ON
PORT	502

State Modbus/TCP

The Modbus/TCP menu gives an overview of all Modbus settings. It contains the following information:
Status (On/Off)
PORT & Port number

Actions:



LEFT button:
 Back to Info: Network

5.3.2.1.3.c Webserver

Webserver	
Status	ON
PORT	80

State Webserver

The Webserver menu is an overview of settings for webserver communication. It contains the following information:
Status (On/Off)
PORT & Port number

Actions:



LEFT button:
 Back to Info: Network

5.3.2.1.3.d Configuration

Configuration	
Status	ON
PORT	44143

State Configuration

The Configuration menu is an overview of the following settings. It contains the information below:
Status (On/Off)
PORT & Port number

Actions:



LEFT button:
 Back to Info: Network

5.3.2.1.4 Info: Busses

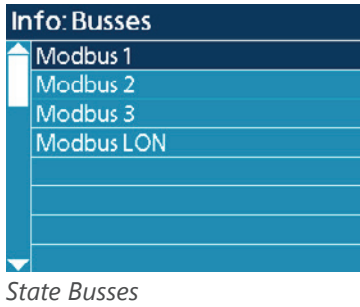

The Info: Busses menu contains the following item menu:

- Modbus 1
- Modbus 2
- Modbus 3
- Modbus LON

Actions:



DOWN button:
Scroll down through the menu



UP button:
Scroll up through the menu



RIGHT or RESET/MENU button:
Select menu item



LEFT button:
Back to Info: D-ReX

5.3.2.1.4.a Modbus 1

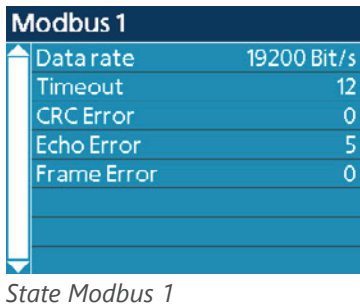

The Modbus 1 menu gives an overview of the Modbus 1's current status, which is used for the device's internal communication. It contains the following information:

- Data rate & set value**
- Timeout & value***
- CRC error & value***
- Echo error & value***
- Frame error & value***

* Accumulated Modbus errors since last system restart. Since errors like these commonly happen because of external influences, individual errors are ignored, but documented according to their type.

The D-ReX will only trigger an error notification after three subsequent failed communication attempts. This information can then be used to examine the source of the error.

Actions:



LEFT button:
Back to Info: Busses

5.3.2.1.4.b Modbus 2

Modbus 2	
Data rate	19200 Bit/s
Terminated	ON
Timeout	0
CRC Error	0
Echo Error	0
Frame Error	0

State Modbus 2

The Modbus 2 menu gives an overview of the Modbus 2's current status, which is used for attaching e.g. a type GMA200-RT or GMA200-RTD module external relay module by GfG. It contains the following information:

- Data rate & set value**
- Terminated (On/Off)**
- Timeout & value***
- CRC error & value***
- Echo error & value***
- Frame error & value***

* Accumulated Modbus errors since last system restart. Since errors like these commonly happen because of external influences, individual errors are ignored, but documented according to their type.

The D-ReX will only trigger an error notification after three subsequent failed communication attempts. This information can then be used to examine the source of the error.

Actions:



LEFT button:
Back to Info: Busses

5.3.2.1.4.c Modbus 3

Modbus 3	
Data rate	19200 Bit/s
Terminated	OFF
Bus Adress	1
Timeout	0
CRC Error	0
Echo Error	0
Frame Error	0

State Modbus 3

The Modbus 3 menu gives an overview of the Modbus 3's current status, which can be connected to e.g. a PLC. It contains the following information:

- Data & set value**
- Terminated (On/Off)**
- Bus address & set value**
- Timeout & value***
- CRC error & value***
- Echo error & value***
- Frame error & value***

* Accumulated Modbus errors since last system restart. Since errors like these commonly happen because of external influences, individual errors are ignored, but documented according to their type.

The D-ReX will only trigger an error notification after three subsequent failed communication attempts. This information can then be used to examine the source of the error.

Actions:



LEFT button:
Back to Info: Busses

5.3.2.1.4.d Modbus LON

Modbus LON	
Data rate	115200 Bit/s
Timeout	0
CRC Error	0
Echo Error	0
Frame Error	0

State Modbus LON

The Modbus LON menu gives an overview of the Modbus LON's current status, which is used exclusively for internal communication of the device and is located between the D-ReX and the optional LonWorks module. It contains the following information:

- Data rate & set value**
- Timeout & value***
- CRC error & value***
- Echo error & value***
- Frame error & value***

* Accumulated Modbus errors since last system restart. Since errors like these commonly happen because of external influences, individual errors are ignored, but documented according to their type.

The D-ReX will only trigger an error notification after three subsequent failed communication attempts. This information can then be used to examine the source of the error.

Actions:



LEFT button:
Back to Info: Busses



The Modbus LON menu is also displayed on devices without a Modbus module, since these settings are made to all devices by default.

5.3.2.2 Info: Measurements

Info: Measurements	
1: Gas Sensor 1	

Info: Measurements

The Info: Measurements menu contains the following menu items:

- 1: Gas Sensor

Actions:



RIGHT or RESET/MENU button:
Select highlighted menu item



LEFT button:
Back to Info

5.3.2.2.1 1: Gas Sensor

1: Gas Sensor 1	
MR:	0.0...100.0 ppm TEOS
Transmitter-Type:	D-ReX EC
Sensor-Type:	MK481-10
Sensor-SN:	8815
First SPAN-Adjust.:	21.Mar.23
	107.42%
Last SPAN-Adjust.:	21.Mar.23
	107.42%

Screen 1

The 1: Gas Sensor menu is an overview of information on the active sensor. Three screens, which can be accessed by scrolling, contain the following information:

Screen 1

- » MR & Measuring range, unit, gas
- » Transmitter type & Measuring principle
 - » D-ReX EC = electrochemical
 - » D-ReX IR = infrared
 - » D-ReX CC = catalytic (pellistor)
- » Sensor type & GfG MK number
- » Sensor-SN & sensor serial number
- » First SPAN- Adjust.*: & Date
Relation to nominal value in %
- » Last SPAN-Adjust.*: & Date
Relation to nominal value in %

1: Gas Sensor 1	
MR:	0.0...100.0 ppm TEOS
Transmitter-Type:	D-ReX EC
Sensor-Type:	MK481-10
Sensor-SN:	8815
First ZERO-Adjust.:	21.Mar.23
	1.58mV
Last ZERO-Adjust.:	25.Aug.23
	1.13mV

Screen 2

Screen 2

- » MR & measuring range, unit, gas
- » Transmitter type & measuring principle
 - » D-ReX EC = electrochemical
 - » D-ReX IR = infrared
 - » D-ReX CC = catalytic (pellistor)
- » Sensor type & GfG MK number
- » Sensor-SN & sensor serial number
- » First ZERO-Adjust.*: & Date
Relation to nominal value in mV
- » Last Zero-Adjust.*: & Date
Relation to nominal value in mV

1: Gas Sensor 1	
MR:	0.0...100.0 ppm TEOS
Input / Address:	Modbus 1/1
Alarm 1:	---
Alarm 2:	---
Alarm 3:	---
Alarm 4:	---

Screen 3 without alarms

Screen 3

- » MR & measuring range, unit, gas
- » Input/Address: & Details
 - » Communication protocol
 - » Input 1 / Modbus address 1
- » Alarm number & settings
 - » Alarm threshold
 - » ▲/▼ alarm on exceeding or falling below
 - » (ICON pin / crossed-out pin)
latching / non-latching
 - » (ICON average = Circle with diagonal line)
Additional information about the average value (e.g. 15 15 minutes / 8 hours) in the lower part of the screen

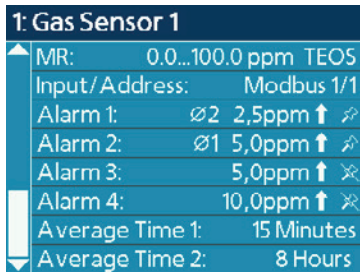

Screen 3 with alarms

Actions:



DOWN button:
Scroll down through the screens



UP button:
Scroll up through the screens



LEFT button:
Back to Info: Measurements

5.3.2.3 Info: Internal Relays

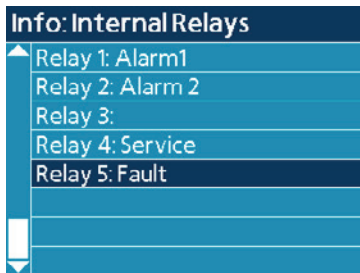

Info: Internal Relays

The Info: Internal relays menu contains the following menu items:

- Relay 1 & Active Alarm e.g. Alarm1
- Relay 2 & Active Alarm e.g. Alarm2
- Relay 3 & Active Alarm
- Relay 4 & Active Alarm e.g. Service
- Relay 5 & Active Alarm e.g. Fault

Actions:



DOWN button:
Scroll down through the menu



UP button:
Scroll up through the menu



RIGHT or RESET/MENU button:
Select menu item



LEFT button:
Back to Info

5.3.2.3.1 Relais (1-5) Alarm X

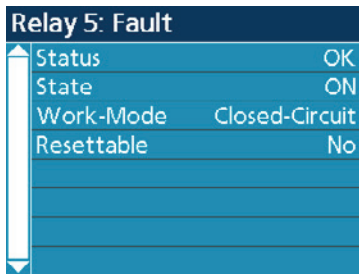

Relays (1-5) Alarm X

The following screen applies to all 5 relays equally. The information behind the relay number indicates the configuration of each relay. The one in the image to the left, for example, is a fault relay.

The Relay (1-5) menu Alarm X menu is an overview of the set alarm. It contains the following information:

Status	Operation status
	Possible relay statuses:

	Communication fault with MC1 (terminal) or an external relay module
	Inhibit
	Relay is inhibited
	Urel > 10.7V
	Relay voltage too high
	Urel < 9.5V
	Relay voltage too low
	Fault
	Relay fault
	OK
	Relay working as intended
State	ON / OFF
Work-Mode	Closed-circuit / Open-circuit
Resettable	Yes / No

Actions:



LEFT button:
Back to Info: Internal relays

5.3.2.4 Help

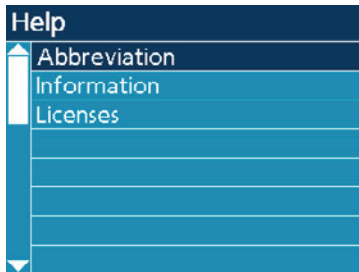

Help

The Help menu contains the following menu items:

- Abbreviation
- Information
- Licenses

Actions:



DOWN button:
Scroll down through the menu



UP button:
Scroll up through the menu



RIGHT or RESET/MENU button:
Select menu item



LEFT button:
Back to Info

5.3.2.4.1 Abbreviation

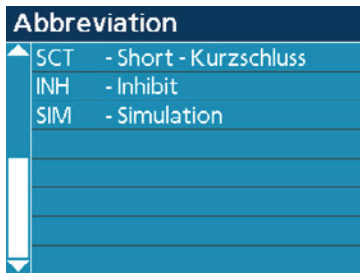

Abbreviation

The Abbreviation menu is an overview of the abbreviations used in the D-ReX' user interface.

Actions:



LEFT button:
Back to Help

5.3.2.4.2 Information

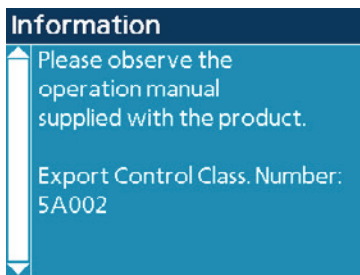

Information

The information menu displays the D-ReX' Export Control Classification Number (ECCN).

Actions:



LEFT button:
Back to help

5.3.2.4.3 Licenses

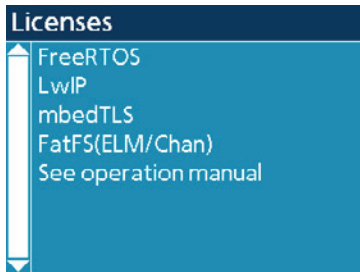

Licenses

The Licenses menu gives information on those software elements that are subject to special license conditions, as they are Open Source etc.

Actions:



LEFT button:
Back to Help

5.3.3 Tests

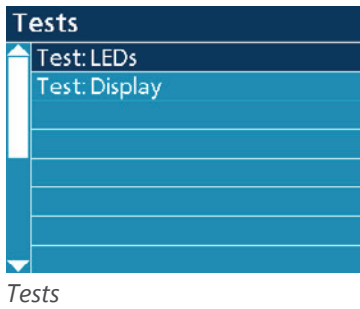

The Tests menu can be used to manually trigger tests for a visual check of the D-ReX. It contains the following menu items:

- Test: LEDs
- Test: Display

Actions:



DOWN button:
Scroll down through the menu



UP button:
Scroll up through the menu



RIGHT or RESET/MENU button:
Trigger test



LEFT button:
Back to main menu



ATTENTION

You will not be notified automatically in case of faults. Only the LEDs and the display will be activated to facilitate performing a visual check.

5.3.3.1 Test: LEDs

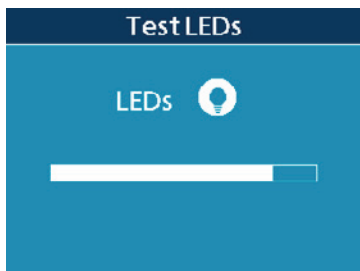

Test: LEDs

During the LED test, the LED test screen will be displayed. It contains a progress bar which will slowly fill. A total of 4 sequences will be addressed.

The D-ReX will then automatically return to the Tests menu.

5.3.3.3 Display Test

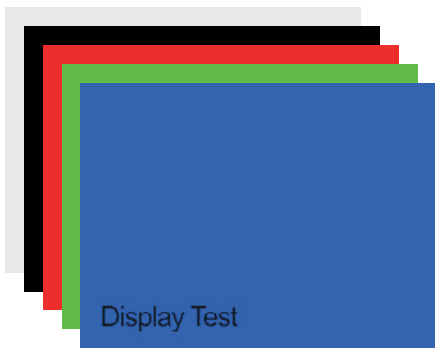

Display Test Screens

During the display test, the entire screen will light up in color to pull attention to any faulty pixels. Additionally, the text "Display Test" will be shown in different positions across the screen.

The sequence of colors is as follows:

- » White (Text in center)
- » Black (Text in upper left / in white)
- » Red (Text in lower right)
- » Green (Text in upper right)
- » Blue (Text in lower left)

The D-ReX will then automatically return to the Tests menu.

5.3.4 Access to the Service menu

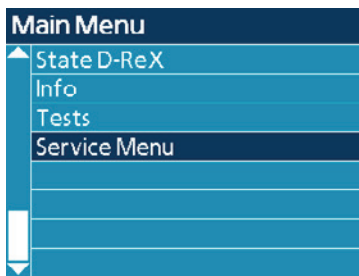

Main menu > Service

To access the service menu, simply select the menu item of the same name in the main menu.

Actions:



RIGHT or RESET/MENU button:
Enter the Service menu.

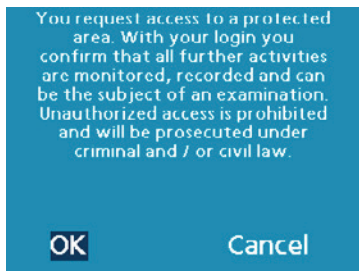

Warning Service menu

You will first receive a warning informing you that you are about to enter a secure area, including the information that any access and changes will be documented.

- OK Continue to login screen (ID and PIN)
- Cancel Back to main menu

Actions:



LEFT or Right button:
Switch between OK and Cancel



RESET/MENU button:
Confirm selection

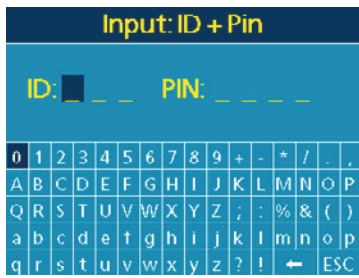

Entering ID + PIN

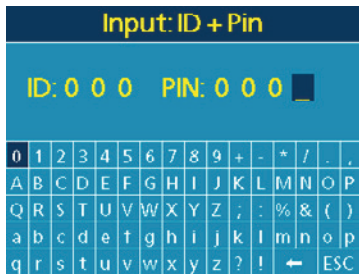

Entering ID + PIN

After confirming your access with **OK**, you will be forwarded to a login screen containing prompts for your **ID** and **PIN** and a virtual keyboard. The ID and PIN are specific to certain groups of users (e.g. admins, service technicians or general users) and alphanumeric. Up to eight user groups with individual rights can be specified.

The standard configuration upon delivery is:

ID = 000
PIN = 0000



ATTENTION

Change the ID and PIN after installation to prevent unauthorized changes to the service menu. To learn more about user groups, refer to chapter Service menu (page > 58).

Actions:



DOWN button:
Navigate down on the virtual keyboard



UP button:
Navigate up on the virtual keyboard



Right button:
Navigate to the right on the virtual keyboard



LEFT button:
Navigate to the left on the virtual keyboard



RESET/MENU button:
Confirm selection



RESET/MENU button on **ESC**
Back to the main menu

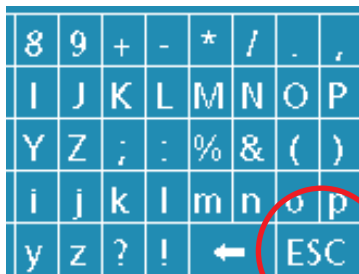

A notification saying **Login failed** will appear if you enter an incorrect ID or PIN. The screen containing the warning and prompt for confirmation or cancelation will then be displayed again.

5.4 Service Menu

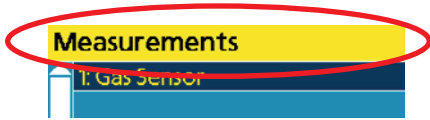

The Service menu can be used to adjust various system settings. The fact that you are currently in the Service menu is indicated by the menu column being highlighted in yellow at all times.

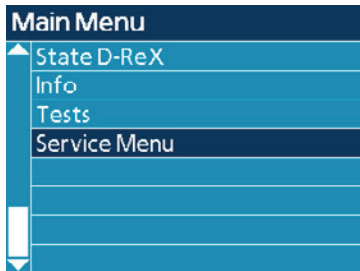

Main menu > Service

You can access the service menu from the main menu. It is protected by a password for security reasons. For detailed information on the login process, refer to chapter 5.3.4 Access to the service menu (page > 56).



CAUTION

Changing the default ID and PIN

Change the ID and PIN after installing the device to prevent unauthorized changes to the service menu.



WARNING

Unauthorized access to the D-ReX' settings

The Service menu may only be used by specially trained users and professionals. Accidental or deliberate changes to the gas detection system's settings can have severe consequences.

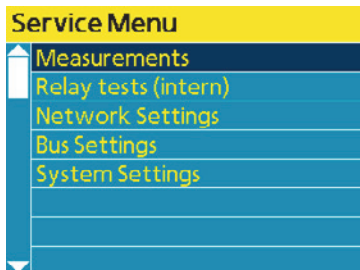

Service menu

The Service menu contains the following menu items:

- Measurements
- Relay tests (intern)
- Network settings
- Bus Settings
- System Settings

Actions:



DOWN button:
Scroll down through the menu



UP button:
Scroll up through the menu



RIGHT or RESET/MENU button:
Select highlighted menu item



LEFT button:
Back to main menu

5.4.1 Measurements

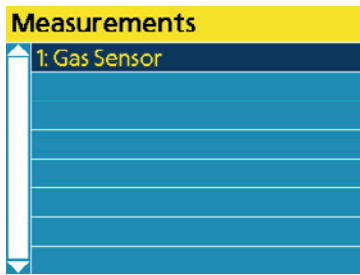

Measurements

The Measurements menu contains the following menu item:
Gas Sensor

Actions:



RIGHT or RESET/MENU button:
Select highlighted menu item



LEFT button:
Back to service menu

5.4.1.1 Gas Sensor

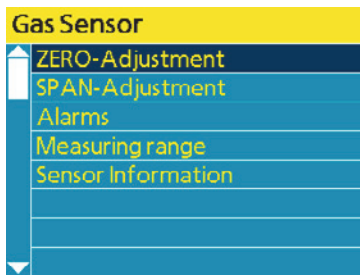

Gas Sensor

The Gas Sensor menu contains the following menu item:

- ZERO-Adjustment
- SPAN-Adjustment
- Alarms
- Measuring range
- Sensor Information

Actions:



DOWN button:
Scroll down through the menu



UP button:
Scroll up through the menu



RIGHT or RESET/MENU button:
Select highlighted menu item



LEFT button:
Back to Measurements

5.4.1.1.1 ZERO-Adjustment

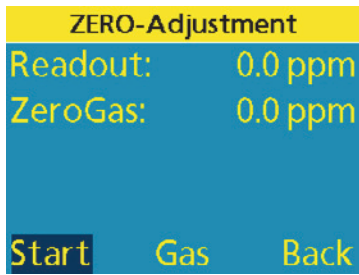

ZERO-Adjustment

The ZERO-Adjustment menu is used to adjust the sensor's zero point.

The SRV/SRQ LED will switch to yellow as soon as you access the menu. It will stay yellow until you return to the main menu.

The screen will display the following informations:

Readout: The current measured concentration of target gas

ZeroGas: 0.0 and the unit

Three control buttons

Start Starts the adjustment

Gas Allows you to manually change the Zero gas concentration

Back Back to gas Gas Sensor menu



SRV/SRQ-LED yellow

Actions:



DOWN button:
Manually lower the value in the Gas function field



UP button:
Manually raise the value in the Gas function field



RIGHT button:
Navigate to the right through the control buttons



RESET/MENU button:
Select control button
In the Gas function field, confirm the set value and go back to the control keys



LEFT button:
Navigate to the left through the control buttons

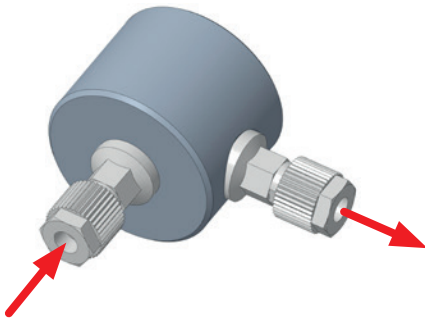

Calibration adapter

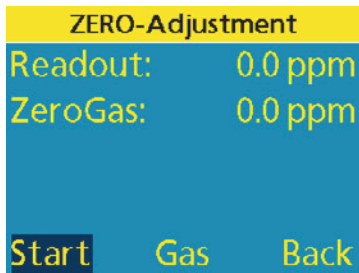

Start ZERO-Adjustment

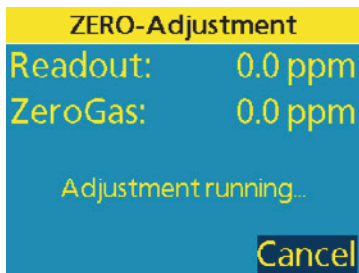

Active ZERO-Adjustment

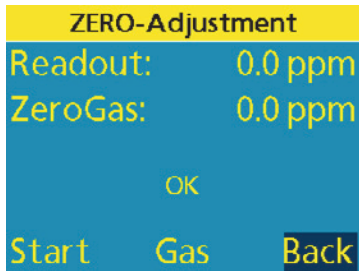

ZERO-Adjustment completed

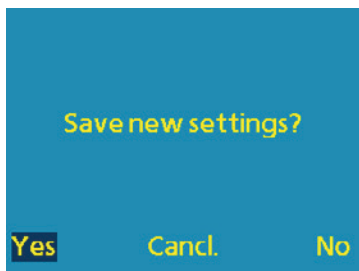

Save settings

To adjust the sensor, follow these steps:

1. Connect the test gas cylinder containing the zero gas to the gas inlet (bottom) of the calibration adapter for internal sensor cartridges (identifiable by its O-rings).
2. If necessary, connect a hose to the calibration adapter's gas outlet (on its side) and position the hose in a way that ensures zero gas is discharged safely.
3. Plug the calibration adapter into the diffusion opening at the bottom of the D-ReX.
4. Enter the service menu and select the menu item Zero-Adjustment: Measurements > gas sensor > Zero-Adjustment.
5. Open the test gas cylinder.
6. Wait until the Readout value has stabilized.
7. Navigate to the Start control button and confirm it with RESET/MENU.
8. The status and results of the adjustment are displayed in the process.
9. Use the Back button to leave the adjustment screen.
10. Close the test gas cylinder.
11. Remove the calibration adapter and leave the service menu.
12. Save your settings.
The device will ask you to save your settings when you leave the service menu.

You will have three choices available on the control buttons:

- Yes Data is saved.
 Continue to main menu.
- Cancl. Data is not saved.
 Continue to Service menu.
- No Data is not saved.
 Continue to main menu.

5.4.1.1.2 SPAN-Adjustment

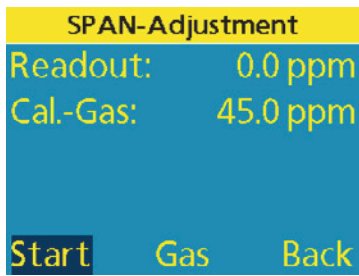

SPAN-Adjustment

The SPAN-Adjustment menu is used to adjust the sensor’s sensitivity.

The SRV/SRQ LED will switch to yellow as soon as you access the menu. It will stay yellow until you return to the main menu.

The screen will display the following informations:

Readout: The current measured concentration of target gas

Cal.-Gas: 0.0 and the unit set before the first adjustment or the last set value of the calibration gas and its unit (in this example: 45.0 ppm)



SRV/SRQ-LED yellow

Three control buttons

- Start Starts the adjustment
- Gas Allows you to change the calibration gas concentration manually
- Back Back to the Gas Sensor menu

Actions:



DOWN button:
Lower the value manually in the Gas function field. The value must match the concentration stated on the test gas cylinder, according to the analysis certificate.*



UP button:
Raise the value manually in the Gas function field. The value must match the concentration stated on the test gas cylinder, according to the analysis certificate.*



RIGHT button:
Navigate to the right through the control buttons



RESET/MENU button:
Select control button
In the Gas function field, confirm the set value and go back to the control buttons



LEFT button:
Navigate to the left through the control buttons

* You may use fresh air instead of test gas for oxygen sensors. If you are using a substitute test gas instead of the target gas, take the sensor’s cross-sensitivity into account. Only substitute test gases recommended by GfG should be used for this purpose.

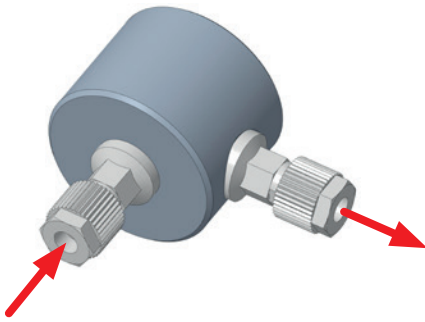

Calibration adapter

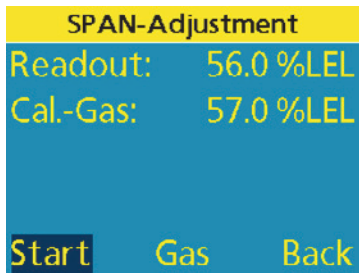

Start SPAN-Adjustment

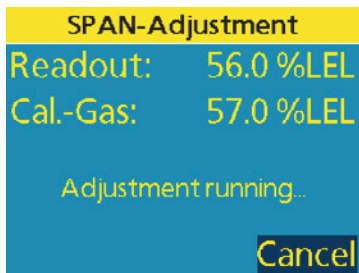

Active SPAN-Adjustment

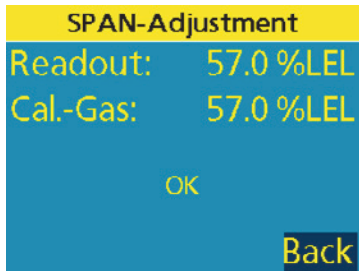

SPAN-Adjustment completed

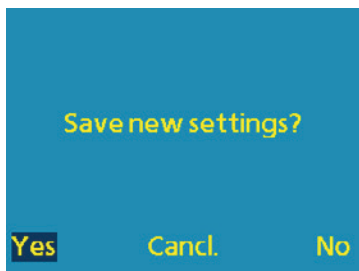

Save settings

To adjust the sensor, follow these steps:

1. Connect the test gas cylinder containing the calibration gas to the gas inlet (bottom) of the calibration adapter for internal sensor cartridges (identifiable by its O-rings).
 2. If necessary, connect a hose to the calibration adapter's gas outlet (on its side) and position the hose in a way that ensures calibration gas is discharged safely.
 3. Plug the calibration adapter into the diffusion opening at the bottom of the D-ReX.
 4. Enter the service menu and select the menu item SPAN-Adjustment:
Measurements > Gas sensor > SPAN-Adjustment
 5. Set the Cal.-gas value to the target gas concentration on the test gas cylinder.
 6. Open the test gas cylinder.
 7. Wait until the Readout value has stabilized.
 8. Navigate to the Start control button and confirm it with RESET/MENU.
 9. The status and results of the of the adjustment are displayed in the process.
 10. Use the Back button to leave the Adjustment
 11. Close the test gas cylinder.
 12. Remove the calibration adapter and leave the Service menu
 13. Save your settings
The device will ask you to save your changes to the settings when you leave the Service menu.
- You will have three choices available on the control buttons:
- | | |
|--------------|---|
| <u>Yes</u> | Data is saved.
Continue to main menu. |
| <u>Abbr.</u> | Data is not saved.
Continue to Service menu. |
| <u>No</u> | Data is not saved.
Continue to main menu. |

5.4.1.1.3 Alarms

Gas Sensor	
Alarm 1:	5,0ppm ↑ ⌘
Alarm 2:	10,0ppm ↑ ⌘
Alarm 3:	15,0ppm ↑ ⌘
Alarm 4:	---

Gas Sensor Alarms

In the Alarms menu, the information in the top line differs from the name of the menu item called up. It will still read Gas Sensor, to make it easier to clearly assign the alarm thresholds to the displayed measured values.



CAUTION

Limited setting options on the D-ReX

Not all alarm setting options that are available on the DReX-Config-software can also be accessed via the D-ReX' buttons.

The first time a new type of sensor is inserted, the data for Alarm 1 and Alarm 2 are automatically entered according to the information specified in the D-ReX' alarm table.

If a sensor is just replaced and if an alarm threshold was changed in the past, or if additional alarm thresholds have been added, these values will also be used for the replacement sensor.

You can adjust the following:

- » The value of the alarm thresholds for measured value alarms. The size of its change intervals corresponds to the sensor's resolution for this measuring range.
- » Alarms for values exceeding ▲ or falling below ▼ the thresholds



CAUTION

Increasing alarm number indicates higher level of danger

For measured value alarms, Alarm 1 cannot be set to a higher value (for exceeding alarms; smaller value for those of values falling below the threshold) than Alarm 2, since it implies a higher level of danger. This does not apply to average value alarms.

- » Alarms latching or non-latching

Actions:



DOWN button:

Scroll down through the four alarms

After selecting an alarm:

- » Pressing briefly: Reduce alarm threshold in individual steps
- » Holding down: Rapidly lower alarm thresholds

After selecting direction of alarm

- » Switch between alarm upon exceeding or falling below

After selecting latching mode

- » Switch between latching and non-latching



UP button:

Scroll up through the four alarm

After selecting an alarm:

- » Pressing briefly: Reduce alarm thresholds in individual steps

Holding down: Rapidly lower alarm threshold

- » After selecting direction of alarm

- » Switch between alarm upon exceeding or falling below

After selecting latching mode

- » Switch between latching and non-latching



RIGHT button:

Switch to the alarm's editing mode



RESET/MENU button:

Switch to the alarm's editing mode

In editing mode, confirm the set value and jump to next position or leave the editing mode



LEFT button:

Back to Gas Sensor

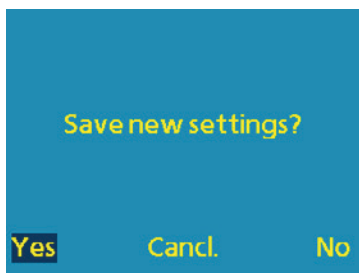

Save settings

If you changed the alarm settings, the change will have to be either confirmed or discarded when you leave the menu.

There are three control buttons available:

- Yes Data is saved.
Continue to main menu.
- Cncl. Data is not saved.
Continue to Service menu.
- No Data is not saved.
Continue with main menu.

5.4.1.1.4 Measuring range

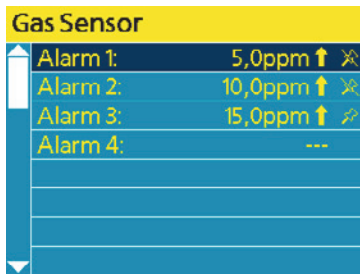

Measuring ranges EC/IR sensor

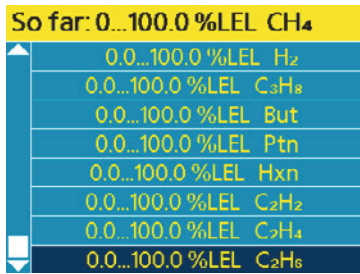

Gases & Measuring ranges CC sensor

For electrochemical sensors (EC) and infrared sensors (IR), the measuring range menu shows all available measuring ranges for the specific sensors. Depending on the sensor, this may be up to three.

For catalytic sensors (CC) used for monitoring the LEL range, it shows all combustible gases the sensor is able to measure. The sensor is by default adjusted to the gas it was ordered for.

The following information is displayed:

- » Previously: Measuring range, unit and gas
The line is highlighted in yellow and shows the measuring range that is currently active, including the gas. It will only change when this menu is opened again after the measuring range or gas has been changed.
- » The active measuring range or the active gas with a check mark at the end.
- » The currently selected line, highlighted in dark blue
- » All other options, highlighted in light blue

Actions:



DOWN button:
Scroll down through the menu



UP button:
Scroll up through the menu



RESET/MENU button:
Select measuring range or gas



LEFT button:
Back to Gas Sensor or the security prompt

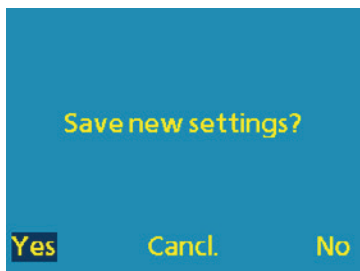

Saving the settings

If you changed the measuring range or selected another gas, you will have to confirm or discard the change when leaving the menu.

Three function buttons are available:

- Yes** Data is saved.
Continue to Gas Sensor
- Cancl.** Data is not saved.
Continue to Measuring range
- No** Data is not saved.
Continue to Gas Sensor



WARNING

Adjustment necessary when changing gas!

If you change the type of gas on a CC sensor, you must readjust the sensor to ensure it is functioning correctly.

For information on adjusting sensors, refer to [chapter XYZ page > 000](#).

5.4.1.1.5 Sensor Information

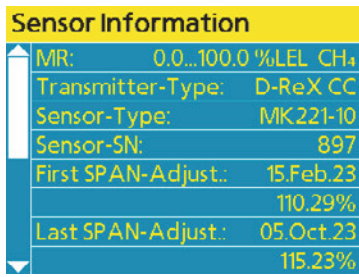

Sensor Information & SPAN

The Sensor Information menu contains the following information:

MR:*	Measuring range, unit and gas
Transmitter-Type:	Type of sensor and measuring principle
Sensor-Type:	Internal designation of the sensor (MK)
Sensor-SN:	Sensor serial number
First SPAN-Adjust.:	Date of the first SPAN adjustment and displayed value
Last SPAN-Adjust.:	Date of the last SPAN adjustment and displayed value

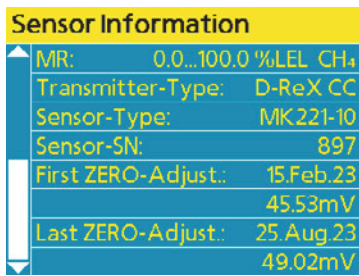

Sensor Information & ZERO

Scroll down to switch from information on SPAN adjustment to information on ZERO adjustment

First ZERO-Adjust.:	Date of the first ZERO adjustment and displayed value
Last ZERO-Adjust.:	Date of the last ZERO adjustment and displayed value

* MR = Measuring Range

5.4.2 Relay tests (intern)

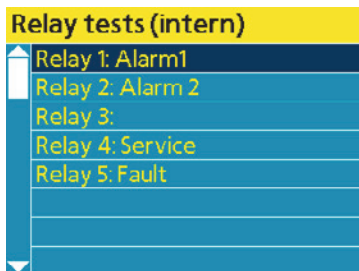

Overview relays

The Relay tests (intern) menu can only be accessed from the service menu if the D-ReX is equipped with internal relays. Otherwise, it does not show up in the list.

The Relay tests (intern) menu contains the following menu items:

- Relays 1: and the set alarm
- Relays 2: and the set alarm
- Relays 3: and the set alarm
- Relays 4: and the set alarm
- Relays 5: and the set alarm

Actions:



DOWN button:
Scroll down through the menu



UP button:
Scroll up through the menu



RESET/MENU or RIGHT button:
Select relay and open test screen



LEFT button:
Back to service menu

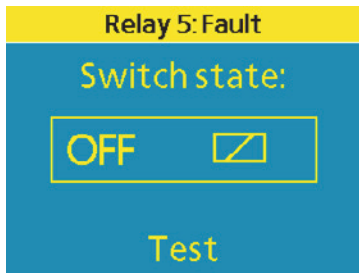

Closed-circuit or OFF

After selecting a relay, a test screen containing the following information is displayed.

- » Relays incl. number and set alarm
- » Switching status (Switchstate) OFF or ON
The switching status depends on whether the relay works on closed-circuit or operating circuit principle. It is configured using the DReX-Config software.
- » Test (merely an indication of the fact that the function test is activated with the RESET/MENU button).

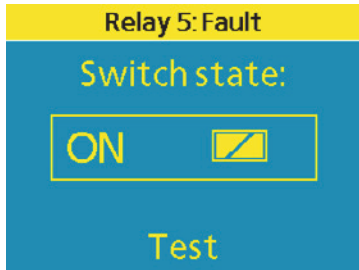

Operating current or ON

Actions:



RESET/MENU button:
Activate relay. You will hear a clicking sound which indicates that alarms or other controlled devices are activated.



LEFT button:
Back to Relay tests (intern)

This test is identical for all five relays.

6. Service

To maintain the functionality of a gas detection system, regular maintenance is required. It requires appropriate knowledge and, in accordance with national regulations, a certificate of competence of the person performing the work, if applicable.

**WARNING****Danger due to incorrect inspection or maintenance**

All inspection and maintenance work may only be carried out by competent persons.

If there are no suitably qualified employees in the company, please contact GfG. We offer appropriate training and refresher courses for your employees as well as suitable service contracts for all maintenance tasks.

6.1 Cleaning and Care

**WARNING****Danger due to electrical shock**

Only clean the device when it is disconnected from the power supply. Switch off all power supplies and secure them against being switched on again before starting any work.

External contaminations of the device's housing can be removed with a damp cloth. Do not use solvents or cleaning agents!

6.2 Service and maintenance

According to DIN EN 60079-29-2 section 11 and DIN EN 45544-4 section 8, maintenance and servicing include testing and inspection during operation as well as repair of the gas detection system.

Also observe all other applicable national and international regulations. In Germany, for example, this would be "DGUV Information 213-056 (Leaflet T 021 Section 9)" and "DGUV Information 213-057 (Leaflet T 023 Section 9)".

Depending on the results, it may be necessary to arrange for or carry out adjustment work and repairs. Any defects found must be rectified immediately!

6.2.1 Visual check

Perform visual checks on a regular basis. The interval between checks must not exceed **1 month**.

The visual check includes:

- » Checking the operation indication and status notifications, e.g. operation indication "On", alarm and fault indications "Off"
- » Checking the housing (e.g. for mechanical and damage external contamination)
- » Checking the sampling system (e.g. for mechanical damage and condensation)
- » Checking the gas inlets for contamination and clogging
- » Documenting the check

The corresponding documentation must include:

- » Identification of the gas detection system (e.g. plant section, measuring point)
- » Confirmation of the completion of the check
- » Found defects
- » Date and name

6.2.2 Functional check

The functional check can be performed at intervals, depending on the gas hazard you need to monitor. Adhere to the respective national regulations for this.

As an example, the inspection interval for gas detection systems monitoring toxic gases/vapors and oxygen as well as for gas detection systems for explosion protection, in Germany is **4 months**.

The functional check includes:

- » Visual check according to section 6.2.1 "Visual check"
- » Supplying zero and test gas
 - » For checking and evaluating the display of measured values (calibration) and, if necessary, adjusting it
 - » For checking and evaluating the response time in accordance with the information in the manufacturer's operation manual
 - » For comparison with the results of previous functional checks
 - » Checking the equipment for transportation and preparation of the sample gas, as well as associated monitoring equipment
 - » Checking the flow rate
 - » Additional supply of test gas at the measuring point to check and evaluate the display of measured values and response time
 - » Checking the impermeability and flow rate
- » Triggering device-specific test function of display elements during operation, without triggering the switching functions
- » Checking the stored notifications, faults and maintenance requests
- » Documenting the check

The corresponding documentation must include:

- » Identification of the gas detection system (e.g. plant section, measuring point)
- » Composition of the test gases used
- » Measured values for zero gas and test gas before and after calibrating / adjusting
- » Evaluation of the response times
- » Found defects
- » Performed work
- » Date and name

A function check eliminates the need to perform a visual check which is due at the same time.

6.2.3 System check (Proof Test)

The system check must be performed at regular intervals. The period between system checks may not exceed **1 year**.

The system check includes:

- » Functional check according to section 6.2.2 Functional check
- » Checking all safety functions, including triggering of switching functions (e.g. start-up of a technical ventilation system or other measures listed in the risk assessment)
- » Checking the parameterization by comparison of target / actual value
- » Checking the signaling and recording devices
- » Documenting the check

The corresponding documentation must include:

- » Identification of the components of the gas detection system (e.g. plant section, measuring point) and any downstream safety equipment
- » Composition of the test gases used
- » Deviations of the parameterization from the set values
- » Measured values for zero gas and test gas before and after calibrating / adjusting
- » Evaluation of the response times
- » Found defects
- » Performed work
- » Date and name

The system check eliminates the need for a function check or visual check that is due at the same time.



WARNING

Danger due to isolated examination of the gas detection system

The system check performed by a qualified person must be carried out in close cooperation with the operator of the plant, especially when checking the safety functions.

If this is not feasible for operational reasons, set points up to which the system check is to be carried out must be determined and documented.

6.2.4 Sensor replacement for external sensor cartridges

1. Detach the cable from the sensor cartridge.



3

2. Detach the sensor cartridge from the mounting bracket or mounting saddle (► page 35)



4

3. Pull the bayonet lock's safety pin downwards to detach the sensor cover.



5

4. Twist the bayonet lock by 90° (anticlockwise).

5. Pull off the bayonet lock.

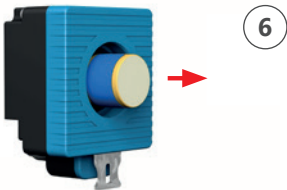

6

6. Pull the sensor out of the cartridge.

7. Wait for at least five seconds and then insert the new sensor into the cartridge.

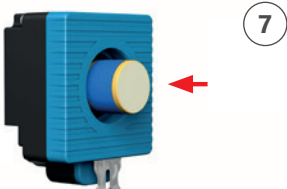

7

8. Reinsert the bayonet lock. Ensure that the pins are aligned correctly. They must be positioned in the grooves specifically designed for this purpose.

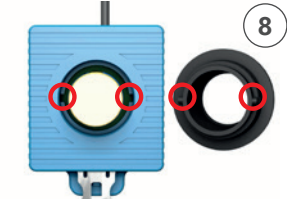

8

9. Twist the bayonet lock by 90° (clockwise).

10. Push the safety pin back up to seal the bayonet lock. If the safety pin cannot be pushed all the way up, the bayonet lock has to be twisted further.



9

11. Reattach the sensor cartridge to the mounting bracket or mounting saddle (► page 35)

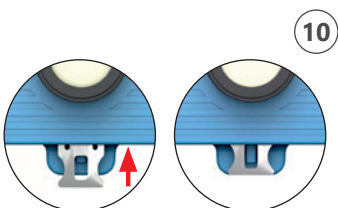

10

6.2.5 Calibration and adjustment

Calibration with zero gas and test gases is used to check the display of measured values.

The adjustment with zero gas and test gas is used to set the displayed measured values. Always adjust the zero point first and the sensitivity second. It is also recommended to check the zero point again after this.

Calibration and adjustment are a part of the functional check and system check.

6.2.5.1 Zero gas and test gas

Generally, unpolluted fresh air (without any interfering gas components) or, in polluted atmospheres, synthetic air can be used as zero gas. Only electrochemical O₂ sensors and infrared CO₂ sensors use 100 vol % N₂.



Information on suitable test gases can be found in the supplied test protocol. Alternatively, you can also deduce suitable gases from the sensor specifications (► page 25 et sqq. Sensor specifications).

For calibrations, the test gas generally has to match the measured gas. The test gas concentration should, if possible, be known in advance, with an accuracy of $\pm 5\%$.

Should the measured gas be difficult to handle as a test gas, a substitute gas may be used. The substitute test gas and the associated sensitivity setting must be determined and documented in consultation with the gas detector's manufacturer. Contact GfG service in this case.



ATTENTION

Particularity of sensor units with CC sensor

Unpolluted fresh air (containing no interfering gas components) or, in polluted atmospheres, synthetic air can be used as zero gas.



ATTENTION

Particularity of sensor units with EC sensor

When selecting a zero gas, a distinction must be made between sensor units with an oxygen sensor and any other electrochemical sensors.

For oxygen sensors, only 100 vol % N₂ may be used. For all other electrochemical sensors, unpolluted fresh air (containing no interfering gas components) may be used as zero gas. In polluted atmospheres, you may also use synthetic air.

**ATTENTION****Particularity of sensor units with IR sensor**

When selecting a zero gas, a distinction must be made between sensor units with a carbon dioxide sensor and any other infrared sensors.

For carbon dioxide sensors, use only 100 vol % N₂. You may also use synthetic air, consisting of N₂ and O₂, for CO₂. For all other infrared sensors, unpolluted fresh air (containing no interfering gas compounds) may be used. In polluted atmospheres, you may also use synthetic air.

6.3 Note on the environmentally safe disposal of used parts



According to GfG's general terms and conditions, the customer assumes responsibility for the environmentally safe disposal of the device or any device components (such as replaced sensors). In Germany, this is regulated by §§11, 12 ElektroG. On request, GfG in Dortmund can also handle the proper disposal.

6.4 Technical specifications

Type designation Version	D-ReX Pol Point of Installation (Pol) for diffusion mode with detached sensor cartridge.
Gas sensors Measuring principle: Available sensor types: Gases:	Depending on sensor Electrochemical sensors (EC) Catalytic sensors (CC) Infrared sensors (IR) See sensor list (► page 30)
Display & control elements	2.4" TFT-Display (320x240 pixels) 5 control buttons 11 Status LEDs for alarms and operation statuses
Climatic conditions Temperature (storage): Temperature (operation): Pressure: Humidity: Mounting location:	-25 to +60 °C (recommended: 0 to +30 °C) -10 to +40 °C (also take the sensor's range of application into account) 70 to 130 kPa (also take the sensor's range of application into account) 0 to 99 % RH (also take the sensor's range of application into account) Inside, or for versions with an increased IP protection class (IP64), outside up to altitudes of 2000 meters above sea level The device is mounted on a TH35 mounting rail (previously TS35) according to DIN EN 60715
External sensor cartridge Temperature (storage): Temperature (operation): Pressure: Humidity: Mounting location:	-25 to +60 °C (0 to +30 °C recommended) -10 to +40 °C (also consider the sensor's area of application) 70 to 130 kPa (also consider the sensor's area of application) 5 to 90 % RH, non-condensing Indoors, up to an altitude of 2000 meters above sea level.
Power supply Operating voltage: Power consumption:	24 V DC (12 to 30 V DC) using stabilized SELV or PELV power supply or PoE with 48 V DC 2.4 W (base load) + 0.2W with LonWorks + 0.3W with 4-20mA output signal + 1.3W with internal relays
Communication & Output signals Digital: Analog: Relays:	10/100Mbit Ethernet (Modbus/TCP) RS-485 Half-Duplex, max. 115200 Baud (Modbus/RTU) Bluetooth 5.2 (optional) LonWorks Current output 4-20 mA (max. load 250 Ω) (optional) 5 internal relays with a changeover contact each (max. 3 A / 30 V DC or min. 10 mA / 5 V) (optional) 16 external relays with a changeover contact each (max. 3 A / 30 V DC or max. 3 A /250 V AC)
Cable junction Cable gland: Examples of connection cables: Terminal connections: RJ45 ethernet connection:	2x M16x1.5, plastic, for cable diameter of 4.5-10mm 5-27 x 0.25mm ² LiYY or 4-24 x 0.25mm ² LiY-CY 4-21 x 0.34mm ² LiYY or 2-16 x 0.34mm ² LiY-CY 2-16 x 0.50mm ² LiYY or 2-12 x 0.50mm ² LiY-CY 2-12 x 0.75mm ² LiYY or 2-8 x 0.75mm ² LiY-CY for 0.2-1.5mm ² / 24-16AWG (one-wire conductor) for 0.25-1.0mm ² (fine stranding conductor with wire end ferrule) Cable at least CAT-5e shielded or, better, CAT-6, CAT-6a, CAT-7

Housing Dimensions: Weight: Housing material:	145 x 105 x 78mm (W x H x D) approx. 650-850 g (depending on device version) Plastic
Sensor cartridge Dimensions: Weight: Material of the housing:	51.5 x 65.5 x 48.2 mm (W x H x D) 64,1 g Plastic
Cable to sensor cartridge Length: Type:	Up to 30 meters Cable to M/F M12 connections
Approvals / Examinations Electromagnetic compatibility: Radio signal: Electrical safety: Housing protection class:	EN 50270:2015 (Emitted interference: Type class I, Interference resistance: Type class II) EN 301489-1 V2.2.3 (2019-11) EN 301489-17 V3.2.4 (2020-04) FCC §15B EN 300 328, Bluetooth LE FCC Part 15.247, Bluetooth LE EN 61010-1 (Degree of contamination 2) EN 60529 Base device IP30 (optionally IP64) Gas sensor IP40 (IP64 when mounted on a fixed saddle)

Firmware versions D-ReX
Main MC2-Firmware 1.02.07
Terminal MC1-Firmware 1.0.77
HTML version 1.02.01

245-002.30b_OM_D-ReX_Pol_EN_v1

As of: December 12, 2023 Subject to change

GfG Gesellschaft für Gerätebau mbH

Klönnestraße 99 | 44143 Dortmund | Deutschland

Phone: +49 231 56400-0
Fax: +49 231 56400-895
Email: info@gfg-mbh.com

[GfGsafety.com](https://www.gfgsafety.com)

smart
GasDetection
Technologies 

6.5 Declaration of Conformity

EU Declaration of Conformity

D-ReX

Created: June 26, 2023 Edited: November 28, 2023

GfG Gesellschaft für Gerätebau mbH

Klönnestraße 99
44143 Dortmund
Phone: +49 (231) 56400-0
Fax: +49 (231) 516313
Email: info@gfg-mbh.com
GfGsafety.com



GfG Gesellschaft für Gerätebau mbH develops, produces and sells gas sensors and gas detection devices which are subject to a **quality management system** as per DIN EN ISO 9001.

This quality management system monitors the production of electric equipment of device category I and II, in categories M1, M2, 1G and 2G, for gas sensors, gas detectors and gas detection systems of protection types "flameproof enclosure", "increased safety", "encapsulated" and "intrinsic safety" and their measuring capabilities. This process is supervised by the notified body DEKRA Testing and Certification GmbH (0158).

The **D-ReX** fixed gas detector complies with directive **2014/30/EU** for electromagnetic compatibility, directive **2014/53/EU** (RED) relating to the process of making radio equipment available on the market and with directive **2011/65/EU** (RoHS) on the restriction of use of certain hazardous substances in electrical and electronic equipment.

Labelling

CE

Directive 2014/30/EU is complied with according to the following standard:

- Electromagnetic compatibility - Electrical apparatus for the detection and measurement of combustible gases, toxic gases or oxygen EN 50270: 2015
- Emitted interference Type class 1
- Interference immunity Type class 2

The electromagnetic compatibility has been tested by EMC test laboratory AMETEK CTS Germany GmbH in Kamen.

Directive 2014/53/EU is complied with according to the following standards:

- Data transmission equipment operating in the 2.4 GHz band EN 300328 V2.2.2: 2019

Reference to directive 2014/30/EU:

- ElectroMagnetic Compatibility (EMC) standard for radio equipment and services
- Common technical requirements ETSI EN 301489-1 V2.2.3: 2019
- Broadband Data Transmission Systems ETSI EN 301489-17 V3.2.4: 2020

Reference to directive 2014/35/EU:

- Safety requirements for electrical equipment for measurement, control and laboratory use
- General requirements. EN 61010-1: 2010 + A1:2019 + A1:2019/AC2019

The compatibility has been tested and certified by test laboratories cetecom advanced GmbH, Essen and AMETEK CTS Germany GmbH, Kamen.

Directive 2011/65/EU is complied with according to the following standard:

- Technical documentation for the assessment of electrical and electronic products with respect to the restriction of hazardous substances EN 50581: 2012

Dortmund, November 28, 2023

.....
QMB B. Siebrecht

6.6 Package dimensions and Mounting template

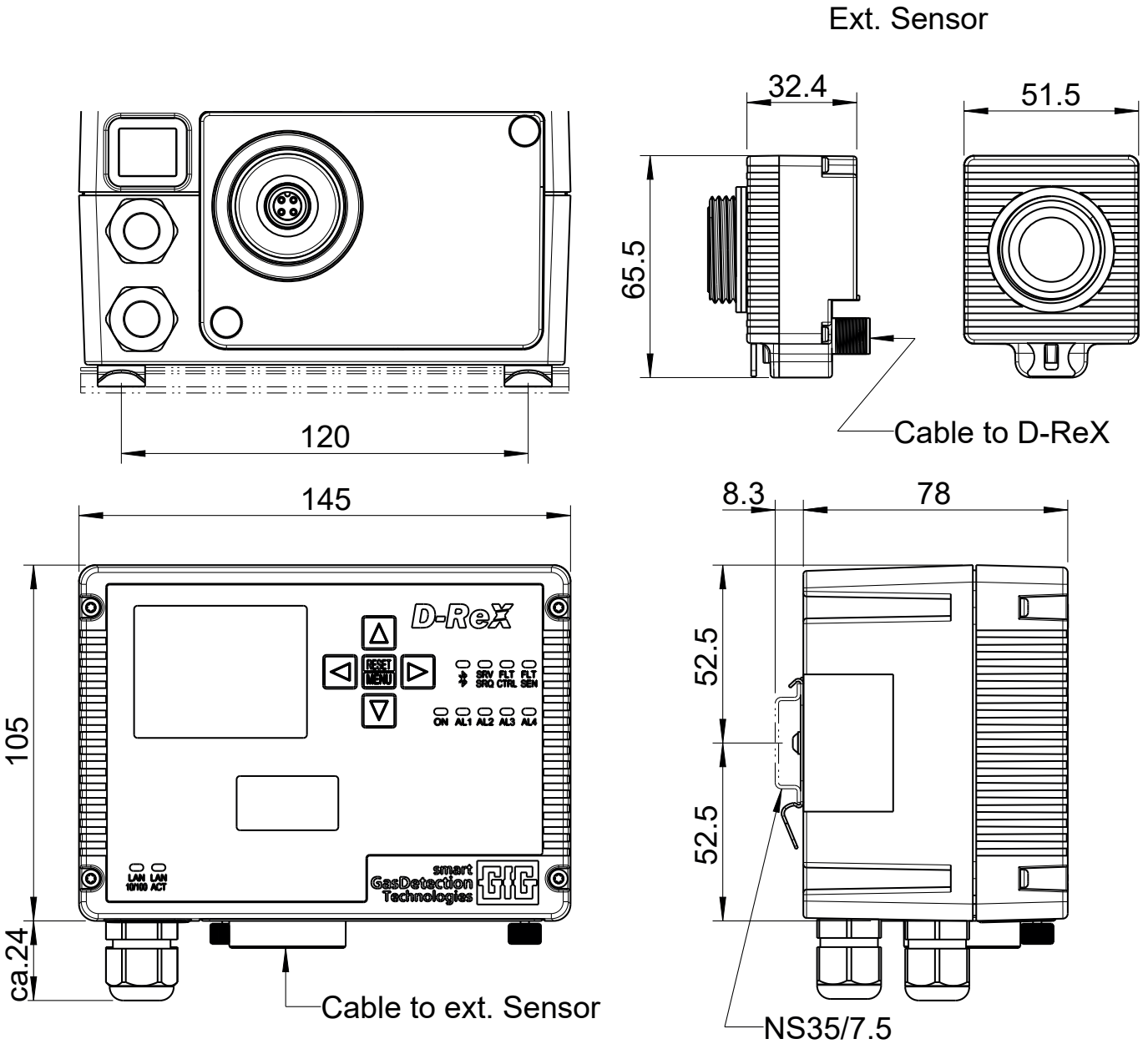

Rev.	Changes	Date	Name	Date	Name	Verified	Title:	
				2023-07-31	Leonhardt	Böttger	D-ReX with ext. sensor Package dimensions and mounting template	
				Adhere to protection note ISO 16016 Schutzvermerk ISO 16016 beachten				
				GfG Gesellschaft für Gerätebau mbH Klönnestr.99, D - 44143 Dortmund			Document-No.:	Page 1 of 1
							245-005.08	
							Replaces:	Replaced by: